

INSTRUCTION MANUAL

DSR-3716 DSR-3709

Digital Video Recorder with Multiplexer Function

About this manual

Before installing and using this unit,
please read this manual carefully.
Be sure to keep it handy for later reference.

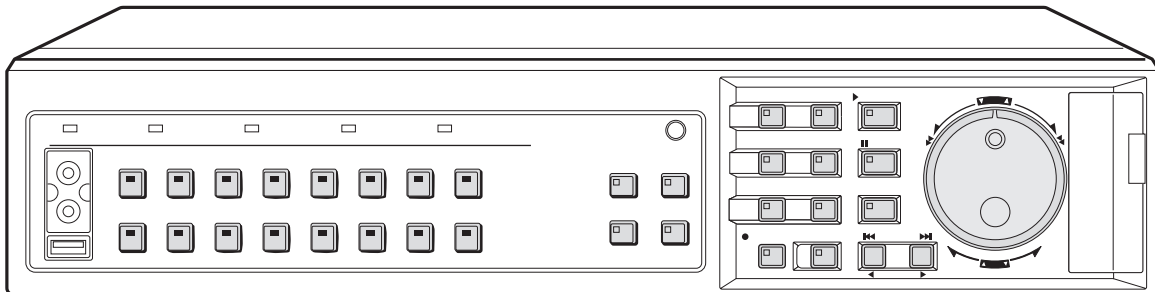

DSR-3716

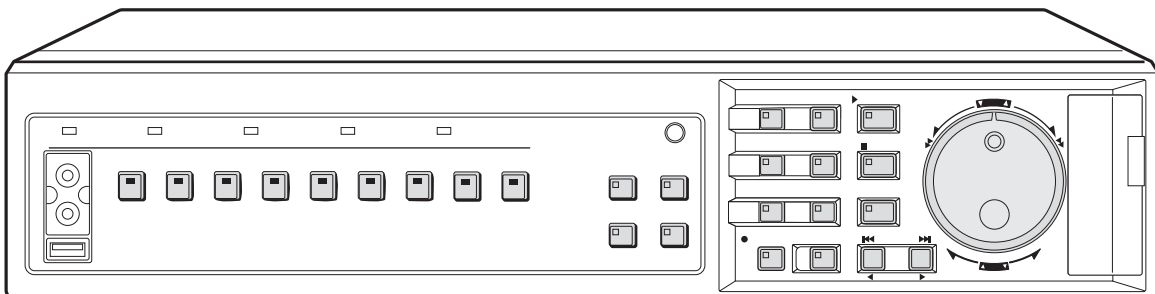

DSR-3709

- Refer to the included CD-ROM for the French and Spanish "INSTRUCTION MANUAL".
- Utilisez le CD-ROM fourni pour consulter le "MANUEL D'INSTRUCTIONS" en français et en espagnol.
- Consulte en el CD-ROM el "MANUAL DE INSTRUCCIONES" en francés y en español.

PRECAUTION



CAUTION

RISK OF ELECTRIC SHOCK
DO NOT OPEN



CAUTION: TO REDUCE THE RISK OF ELECTRIC SHOCK, DO NOT REMOVE COVER (OR BACK). NO USER-SERVICEABLE PARTS INSIDE. REFER SERVICING TO QUALIFIED SERVICE PERSONNEL.

WARNING: To reduce the risk of fire or electric shock, do not expose this appliance to rain or moisture.

CAUTION: Changes or modifications not expressly approved by the manufacturer may void the user's authority to operate this equipment.



The lightning flash with arrowhead symbol, within an equilateral triangle, is intended to alert the user to the presence of uninsulated "dangerous voltage" within the product's enclosure that may be of sufficient magnitude to constitute a risk of electric shock to persons.



The exclamation point within an equilateral triangle is intended to alert the user to the presence of important operating and maintenance (servicing) instructions in the literature accompanying the product.

This equipment has been tested and found to comply with the limits for a Class B digital device, pursuant to part 15 of the FCC Rules.

These limits are designed to provide reasonable protection against harmful interference in a residential installation.

This equipment generated, uses and can radiate radio frequency energy and, if not installed and used in accordance with the instructions, may cause harmful interference to radio communications. However, there is no guarantee that interference will not occur in a particular installation.

If this equipment does cause harmful interference radio or television reception, which can be determined by turning the equipment off and on, the user is encouraged to try to correct the interference by one or more of the following measures:

- Reorient or relocate the receiving antenna.
- Increase the separation between the equipment and receiver.
- Connect the equipment into an outlet on a circuit different from that to which the receiver is connected.
- Consult the dealer or an experienced radio/TV technician for help.

For the customers in Canada

This class B digital apparatus complies with Canadian ICES-003.

CAUTION

Danger of explosion if battery is incorrectly replaced. Replace only with the same or equivalent type recommended by the manufacturer. Discard used batteries according to the manufacture's instructions.

Declaration of Conformity

Model Number : DSR-3716/3709
Trade Name : SANYO
Responsible party : SANYO FISHER COMPANY
Address : 21605 Plummer Street,
Chatsworth, California 91311
Telephone No. : (818) 998-7322

- This device complies with Part 15 of the FCC Rules. Operation is subject to the following two conditions:
 - (1) this device may not cause harmful interference, and
 - (2) this device must accept any interference received, including interference that may cause undesired operation.

Location

For safe operation and satisfactory performance of your unit, keep the following in mind when selecting a place for its installation:

- Shield it from direct sunlight and keep it away from sources of intense heat.
- Avoid dusty or humid places.
- Avoid places with insufficient ventilation for proper heat dissipation. Do not block the ventilation holes at the top and bottom of the unit. Do not place the unit on a carpet because this will block the ventilation holes.
- Install the unit in a horizontal position only.
- Avoid locations subject to strong vibrations.
- Avoid moving the unit between cold and hot locations.
- Do not place the unit directly on top of a monitor TV, as this may cause playback or recording problems.

Avoiding Electrical Shock and Fire

- Do not handle the power cord with wet hands.
- Do not pull on the power cord when disconnecting it from an AC wall outlet. Grasp it by the plug.
- If any liquid is spilled on the unit, unplug the power cord immediately and have the unit inspected at a factory-authorized service centre.
- Do not place anything directly on top of this unit.

SERVICE

This unit is a precision instruments and if treated with care, will provide years of satisfactory performance. However, in the event of a problem, the owner is advised not to attempt to make repairs or open the cabinet. Servicing should always be referred to your dealer or Sanyo Authorized Service Centre.

Licensed Under U.S. Patent No. 4,974,088

INTRODUCTION

Main features

- **The digital video recorder records video from monitoring cameras to its internal hard disk, it can display the video being displayed on a monitor split into four, nine or sixteen screens, and it can also display recorded video in the same way.**

The DSR-3709 can only display split screen video in four or nine screens.

- **Separately-sold hard disks (80, 160, 250, or 300 GB) can be installed to further increase this large memory capacity.**
- **Complete range of recording and playback functions**
 - Simultaneous recording and playback of video.
 - Timer recording allows recordings to be made at different times each day.
 - Zoom allows a certain section of live and playback video to be magnified.
 - Alarm recording allows the actions of intruders to be recorded.
 - The video from specific cameras can be masked using a gray pattern to prevent it being monitored.
 - Motion sensing can be used with each camera, and alarms can be setup to give priority to the recording of moving images.
 - By connecting multiple digital video recorders, it is possible to perform analog series recording in which, once the capacity of one hard disk is reached, recording continues automatically on the next digital video recorder.
- **Search function - lets you instantly display the desired recording. (→P.30)**
 - Searching in order of alarm occurrence using alarm search
 - Searching by thumbnail using alarm search
 - Searching by date/time
 - Searching within the archive area
 - Searching for intruder motion using motion detection search

- **Two-level security lock function - lets you restrict users for data and equipment management. (→P.89)**

- **Expandable, can be connected to a PC**
 - Recorded video can be copied to CompactFlash cards and CD-R/RW.
 - A built-in LAN terminal provides support for network control, thus facilitating live monitoring, camera control, playback, searches, and menu setting.
 - Monitoring can be carried out on two different monitor screens - namely, the main monitor and monitor 2. In addition, the main monitor can be viewed in split-screen mode while the monitor 2 is used for full screen viewing or automatic camera selection.
 - Dome cameras can be controlled by button operations on the digital video recorder.
 - Images stored on a CompactFlash card can be printed directly from a printer.

Accessories

Check that you have all the parts shown below.

Power cord

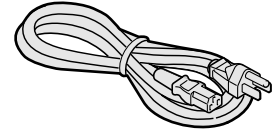

Core clamp

- 1 large, 1 small
- Large core clamp
For LAN cable
- Small core clamp
For RS-485 cable

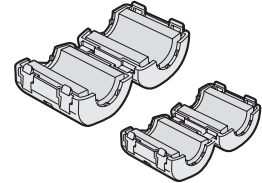

Power cord tie

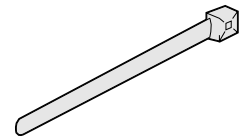

- Instruction Manual (DVR)
- Manual for Remote
Operation by
Network
Connection
- Quick Guide
- CD-ROM Manual

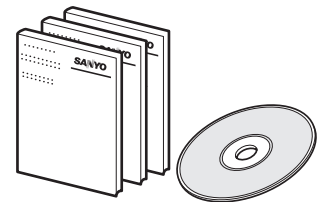

Symbols used in this manual



Information describing operation methods or how to get the most out of functions.



Information describing the correct use of the digital video recorder.

(→P. xx) indicates the page to be referred to.

Copyright

- This manual and software are copyrighted by Sanyo Electric Co., Ltd.
- Brand and product names used in this manual are the trademarks or registered trademarks of their respective companies.

Except for personal use, copyright law prohibits the use of recorded copyrighted images without the permission of the copyright holder.

CONTENTS

INTRODUCTION

1 BEFORE USE5	3 INSTALLATION AND CONNECTIONS 11
Notes on handling the internal HDD5	Basic connections 11
Notes on installation locations5	Connecting RS-485 terminals 11
The hard disk and cooling fan are consumable components.6	Connecting SANYO protocol devices (Dome Cameras) 13
Important recordings6	Connecting an amplifier 13
Protection of the hard disk6	Connecting ALARM IN terminals 13
Backup battery6	Connecting SENSOR ALARM OUT terminals 14
2 NAMES AND FUNCTIONS OF PARTS7	Connecting CONTROL terminals 14
Front panel7	Connecting the power cord 14
Rear panel10	

OPERATION

1 PREPARING FOR USE15	5 SEARCHING FOR RECORDED VIDEO 30
Operation display area15	Alarm search 31
Changing the position of the operation display area16	Alarm thumbnail search 32
Changing the language16	Time/date search 32
Setting the time17	Archive area search 34
The internal hard disk18	Motion detection search 34
2 VIEWING VIDEO FROM A CAMERA19	6 SAVING (COPYING) RECORDED VIDEO 38
Viewing on a full screen19	Copying video to the hard disk's archive area 39
Viewing on quad screens19	Copying video to a CompactFlash card or Microdrive 41
Viewing on multi screens (9 screens/ 16 screens)20	Printing images from CompactFlash cards (quick print) 43
Viewing on plus screen20	Copying video to CD-R/RW 45
Viewing with automatic screen selection21	
Viewing on the monitor 221	
3 RECORDING23	
Normal recording23	
Timer recording23	
Alarm recording24	
Pre-alarm recording25	
4 PLAYBACK26	
Playing video on a full screen26	
Fast-forward and fast-rewind playback26	
Changing the playback speed27	
Enlarging the playback video27	
Viewing still images28	
Performing frame advance (forward or reverse)29	
Playing video on multiple screens29	

SETTINGS

1 MENU CONFIGURATION AND OPERATIONS47
 Basic menu operations47
 Restoring menu setting items to their default values48
 Sub-menu configuration49

2 INITIAL SET51
 Initial settings51
 Setting the time51
 Setting the daylight saving51
 External clock setting53
 Detecting connected cameras54
 Setting camera titles55
 Setting holidays56
 Setting time periods57

3 RECORD SET60
 Settings for recording60
 Normal recording easy setup60
 Displaying the recording areas64
 Changing recording areas65
 Setting overwrite permission66
 Setting recording conditions67
 Setting series recording69
 Setting auto deleting71
 Setting normal recording71
 Setting program recording73
 Timer settings74
 Setting alarm recording77
 Setting the motion sensors81
 Setting alarm operation and display84
 Canceling alarms85

4 GENERAL SET 86
 General settings 86
 Setting data display 86
 Setting display for video loss 87
 Setting the buzzer 88
 Setting the security lock 89
 Setting and initializing the hard disk 92
 Expanding the hard disk capacity 93
 Network settings 93
 Setting RS-485 96
 Setting camera control 97

5 SCREEN SET 100
 Setting quad, multi 9 and 16 display 100
 Setting the period and monitors for automatic screen selection 102
 Setting masks 104
 Setting the color level 105

6 POWER LOSS/USED TIME 107

7 INITIALIZATION LOG 108

8 COPY MENU SETTINGS 109
 Saving menu settings on a CompactFlash card 109
 Loading settings from a CompactFlash card 110

OTHER

1 INTERFACE SPECIFICATIONS111
 RS-485 specifications111
 SANYO protocol command table112

2 SPECIFICATIONS113
 Specifications113
 Dimensions114
 UL disclaimer statement114
 Table of recording rate and times115
 Table of recording rate settings117
 Table of pre-alarm recording times118
 Terminal board specifications119

3 MENU SETTING SEQUENCE 121

INDEX 123

Notes on handling the internal HDD

This digital video recorder uses an internal hard disk drive (HDD).

Be sure to observe the following points carefully when operating, setting-up, or servicing the digital video recorder.

■ Do not subject the digital video recorder to sudden impact or vibration.

If the digital video recorder is subjected to sudden impact or vibration, it may damage the HDD or cause corruption of the data stored within it.

- Do not move the digital video recorder while the power is turned on. Always ensure that the power is turned off before removing the digital video recorder from or placing it in a rack.
- When transporting the digital video recorder, pack it securely using the specified materials. In addition, choose a method of transportation that minimizes vibration.
- When placing the digital video recorder on the floor or another similar surface, attach the specified pads to its base and place it down gently.

■ Do not move the digital video recorder for 30 seconds after turning off the power.

After the power is turned off, the disk inside the HDD will continue to spin for a brief period due to inertia, and the heads will be in an unstable condition.

During this period, the digital video recorder is even more susceptible to damage from sudden impact and vibration than when it is turned on. Make sure that the digital video recorder is not subjected to even gentle vibration for at least 30 seconds after turning off the power.

■ Do not operate the digital video recorder when condensation has formed on it.

If the digital video recorder is operated in this type of condition, there is a possibility that it will be permanently damaged.

If the temperature around the digital video recorder changes suddenly, wait for it to stabilize before operating the digital video recorder.

■ Notes on replacing the HDD

Be sure to follow the correct procedure when replacing the HDD.

- HDDs that have been removed from their packing may not operate correctly if they are subjected to sudden impact or vibration. It is recommended that you place the HDD on a soft, level surface with the printed circuit board facing upward after it has been unpacked.
- Take care to avoid subjecting the HDD to sudden impact or vibration when removing and tightening screws as part of the HDD replacement procedure. Tighten all screws securely to ensure that they do not loosen.
- The HDD is sensitive to static electricity; accordingly, you should take the appropriate precautions to prevent the buildup of static charges.

■ Handling a detached HDD unit

If transporting or storing the HDD unit in a detached condition, be sure to first of all pack it using the specified materials.

In addition, choose a method of transportation that minimizes vibration.

Notes on installation locations

The hard disk is sensitive to dust, sudden impact, and vibration; furthermore, it should not be used near magnetic objects. The following precautions should be observed in order to prevent the loss of recorded data:

- Do not subject the digital video recorder to sudden impact.
- Do not use the digital video recorder on a vibrating or unstable surface.
- Do not disconnect the power plug from the wall outlet during recording or playback.
- Do not use the digital video recorder in areas with extreme temperature changes (i.e., 10°C or more per hour).
- Condensation may occur if the digital video recorder is moved to an area with a significantly different temperature or high humidity. If the digital video recorder is used while condensation is present inside it, operating problems may occur.
- Do not install the digital video recorder inside motor vehicles, trains, or other areas under constant vibration.
- The digital video recorder has ventilation holes on its left, rear, and bottom panels. Ensure that these holes are not blocked after installation.
- Do not use the digital video recorder in a bookshelf, box, or any other area with poor ventilation.
- This digital video recorder is designed for use in a horizontal orientation, and vertical setup may result in malfunction.
- When installing the digital video recorder in a rack, ensure that a gap of at least 5 cm is provided at the top and bottom.

The hard disk and cooling fan are consumable components.

If used in an ambient temperature of 25°C, the hard disk should generally be replaced after 2 years; and the cooling fan after 3 years. These figures are intended as a general guideline only and should not be taken as a guarantee of component performance.

The POWER indicator will flash if a problem occurs with the hard disk or fan. (→P.7)

Important recordings

- Always perform test recording in advance to confirm whether the digital video recorder's playback is normal.
- Note that Sanyo will accept no responsibility for losses occurring as a result of recording or playback problems caused by malfunction of this digital video recorder or any connected devices.
- As a precaution against malfunction or accidents, it is advisable to periodically back up important recordings or to perform mirroring.

Protection of the hard disk

The hard disk is checked automatically when the power is turned on. If an abnormality is detected, the POWER indicator will begin to flash or an error message will be displayed. If you need initialize the hard disk or to save images stored on it, contact the dealer from whom you purchased this digital video recorder.

Backup battery

The digital video recorder comes with a built-in lithium battery. If power is supplied continuously for at least 48 hours after setting the date and time, the clock will continue to operate normally for up to 30 days without a supply of power.

When disposing of this digital video recorder, contact the dealer from whom it was purchased for information on how to dispose of the lithium battery.

DSR-3716

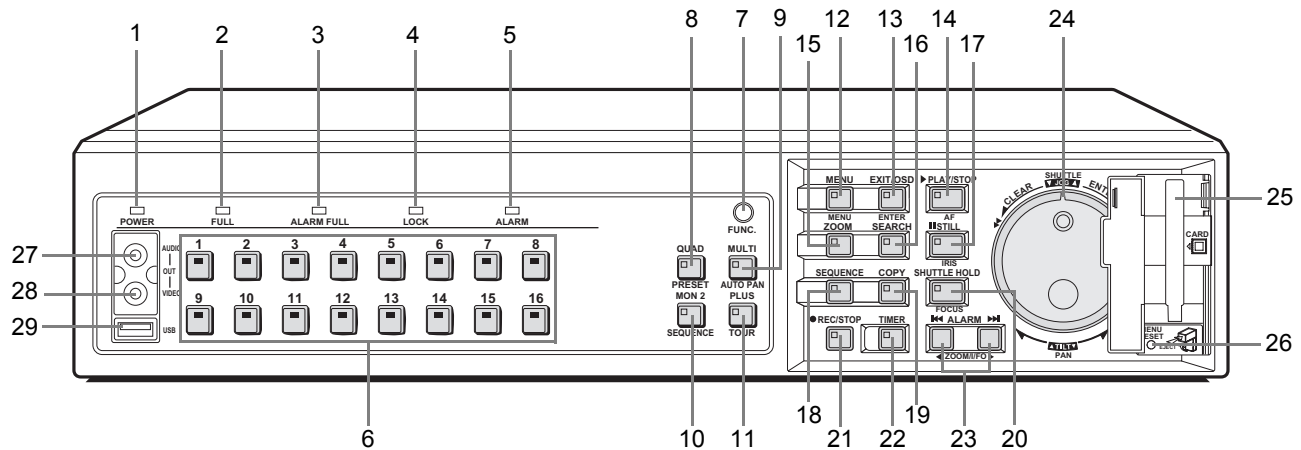

Front panel

1. POWER indicator

The POWER indicator will light up when the power is turned on.

If the internal HDD or fan begins to malfunction, this indicator will be flashed.

2. FULL indicator (→P.68)

The FULL indicator will begin to flash when the amount of available memory in the hard disk's normal recording area drops to the percentage specified using menu settings. In addition, recording will stop automatically when no more memory is available, and the FULL indicator will switch to a permanently lit condition.

This indicator can then be turned off by performing "AREA FULL RESET" using menu settings.

3. ALARM FULL indicator (→P.68)

The ALARM FULL indicator will begin to flash when the amount of available memory in the hard disk's alarm recording area drops to the percentage specified using menu settings.

In addition, recording will stop automatically when no more memory is available, and the ALARM FULL indicator will switch to a permanently lit condition.

This indicator can then be turned off by performing "AREA FULL RESET" using menu settings.

4. LOCK indicator (→P.91)

The LOCK indicator lights up when operation has been locked using <SECURITY LOCK SET>.

An alarm will be sounded if a button is pressed in this condition. In addition, a password entry screen will be displayed on the monitor at this time.

If the correct administrator password is entered, the lock condition will be cancelled and the LOCK indicator will turn off.

5. ALARM indicator

The ALARM indicator flashes during alarm recording, and it is lit up during pre-alarm recording.

6. [CAMERA SELECT] buttons and indicators

When one or more cameras have been connected to the VIDEO IN terminals on the digital video recorder's rear panel and the appropriate [CAMERA SELECT] button is pressed, the corresponding indicator lights up and the video feed from that camera is displayed on-screen.

- During quad, multi 9 or 16 screen display:
The indicators corresponding to the cameras being displayed on the monitor are lit up.
- If video is lost:
The indicator starts to flash.
- If an alarm occurs:
The indicator for the corresponding camera starts to flash.

7. [FUNC.] button and indicator (→P.99)

Switch to normal mode or camera control mode. Press button for camera control mode and indicator will light. Press button again to return to normal mode. Indicator turns off.

8. [QUAD] button and indicator (→P.19)

The [QUAD] button is used to display video in quad screens, and the indicator will light up when this type of display is being presented. The QUAD indicator will turn off when a different screen display mode is adopted.

9. [MULTI] button and indicator (→P.20)

The [MULTI] button is used to display video in multi 9 or 16 screens, and the indicator will light up when this type of display is being presented. The MULTI indicator will turn off when a different screen display mode is adopted. The DSR-3709 can only display video in nine screens.

10. [MON2] button and indicator (→P.21)

If the [MON2] button is pressed while a monitor is connected to the MON2 output terminal on the rear panel, it will be possible to change the monitor 2 output video. The [CAMERA SELECT] and [SEQUENCE] buttons can be used, and the indicator will be lit up during the setting procedure.

DSR-3709

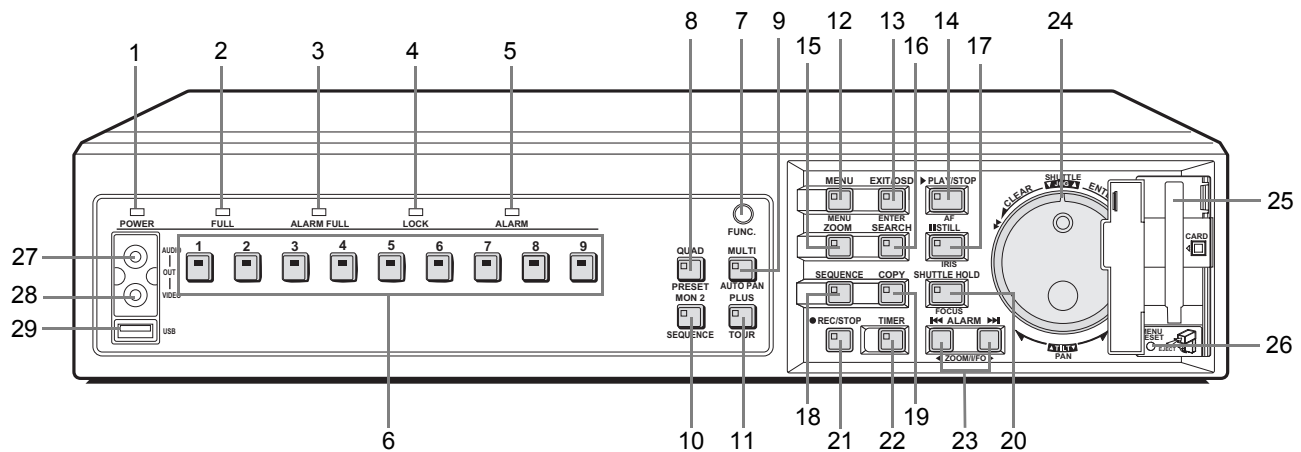
**11. [PLUS] button and indicator (→P.20)**

The [PLUS] button is used to enlarge video from a single camera to quad screen size during multi 9 or multi 16 screen display.

For DSR-3709, this operation is available only when in multi 9 screen display.

12. [MENU] button and indicator

The [MENU] button is used to display the menu screens (i.e., setting screens), and the indicator lights up while any of these screens is being displayed.

13. [EXIT/OSD] button and indicator

● EXIT

The [EXIT/OSD] button is used to exit the main menu or a sub-menu. When a menu is displayed, the indicator turns off; when the menu is closed and the normal display is restored, the indicator lights up.

● OSD (→P.16)

Each time the [EXIT/OSD] button is pressed while the digital video recorder is recording, playing, or stopped, the operating display location moves in the order of top of screen, bottom of screen, to hidden; furthermore, the indicator lights up when this information is being displayed.

14. [PLAY/STOP] button and indicator (→P.26)

When the [PLAY/STOP] button is pressed, a recording from the normal recording area or alarm recording area is played and the indicator lights up. When pressed during playback, this button stops the digital video recorder.

15. [ZOOM] button and indicator (→P.19, 27)

When the [ZOOM] button is pressed during monitoring or playback on a full screen, a portion of the playback video is magnified and the indicator lights up.

16. [SEARCH] button and indicator (→P.31)

When the [SEARCH] button is pressed while the digital video recorder is recording or stopped, the search menu is displayed and the indicator lights up. The search menu can be closed by pressing this button once again.

17. [STILL] button and indicator (→P.28)

When the [STILL] button is pressed during playback, the current frame is displayed as a still image and the indicator lights up. Playback can be resumed by pressing this button once again.

18. [SEQUENCE] button and indicator (→P.21)

The [SEQUENCE] button can be pressed during monitoring to automatically switch between screen display. When pressed, the indicator begins flashing and the display is changed automatically. The lighting condition of CAMERA SELECT indicators also changes in response to the screen display.

19. [COPY] button and indicator (→P.39)

The [COPY] button is used to copy recorded video to the hard disk's archive area, to a CompactFlash card, CD-R/RW or to a Microdrive.

The indicator lights up during the copy process.

20. [SHUTTLE HOLD] button and indicator (→P.26)

The [SHUTTLE HOLD] button is used to lock shuttle dial operation for a constant speed of playback or slow playback. The indicator lights up while the shuttle dial is locked.

When a password has been set, furthermore, this button can be pressed for at least three seconds to activate the security lock.

21. [REC/STOP] button and indicator (→P.23)

The [REC/STOP] button is pressed to start normal recording, and the indicator lights up during this process. Furthermore, pressing this button for at least three seconds stops recording and turns off the indicator.

DSR-3716

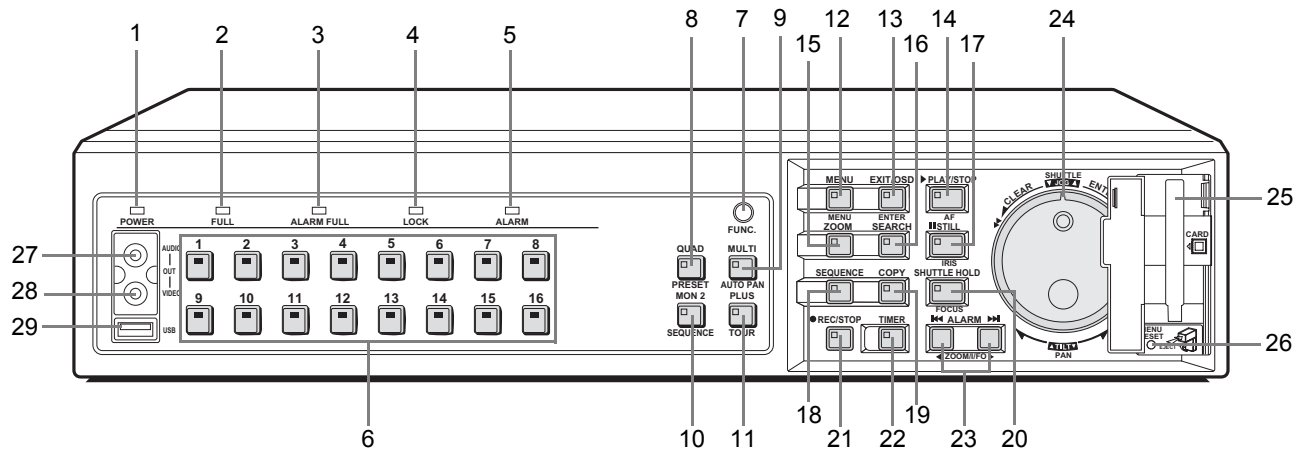
**22. [TIMER] button and indicator (→P.23)**

If the [TIMER] button is pressed while the recording is stopped, timer recording standby mode is adopted and recording will then start automatically at the set time. The indicator will be lit up while in timer recording standby mode or timer recording.

If the button is pressed during timer recording, this process is stopped and the indicator turns off. Furthermore, if the [TIMER] button is pressed when in timer recording standby mode, indicator is turned off and timer recording is cancelled.

23. [ALARM] buttons (→P.31)

When an [ALARM] button is pressed during playback or still, the digital video recorder skips to the next earlier or next later alarm.

24. Jog dial (inside) and shuttle dial (outside)

- During playback:
 - Use the jog dial to change the playback speed.
 - Use the shuttle dial to perform fast-forward or fast-reverse playback.
- During menu display:
 - Use the jog dial to move the cursor and to change setting values. Use the shuttle dial to confirm settings.

25. CompactFlash card slot (→P.41)

This slot is used to house a CompactFlash card or Microdrive.

26. [MENU RESET] button (→P.48)

The [MENU RESET] button is used to default menu settings.

When setting motion sensors, furthermore, all sensors on the same line as the cursor can be turned on simultaneously by pressing this button.

27. Audio output terminal

Audio output is the same as that of the rear panel AUDIO OUT terminal.

28. Video output terminal

This terminal outputs the same video as that of the MAIN MONITOR output terminal on the rear panel.

29. USB terminal (→P.45)

This terminal connects to a recordable CD-R/RW drive.

! CAUTION

- The USB terminal is for the use of the recommended Sanyo CD-R/RW drive (sold separately). Non-recommended peripherals cannot be connected.
- For recommended recordable drives, check the Sanyo homepage or ask at your local Sanyo dealer.

Sanyo website URL:

<http://www.sanyosecurity.com>

DSR-3716

(The number of terminals for the DSR-3709 may differ. For more details, see below.)

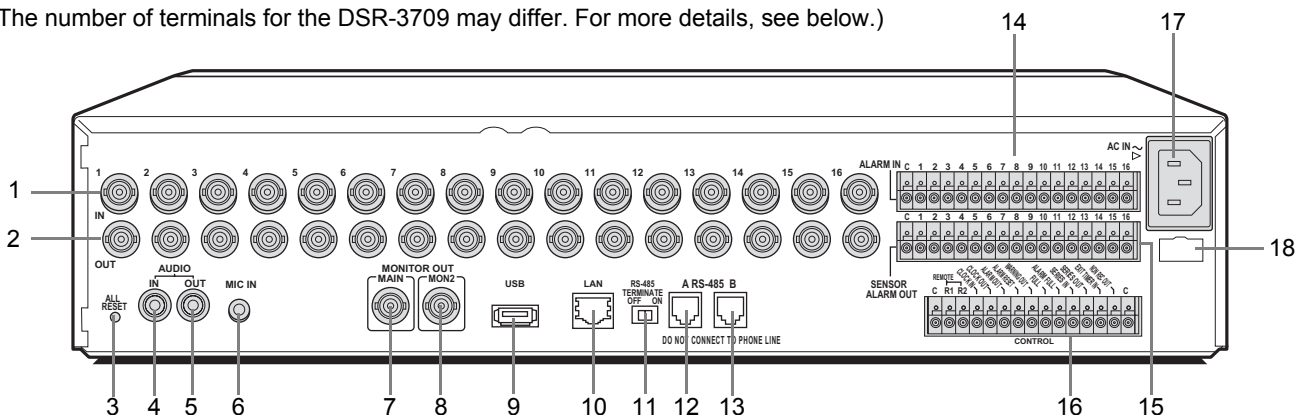

Rear panel

1. VIDEO IN terminals

The DSR-3709 has nine VIDEO IN terminals.

2. VIDEO OUT terminals

The DSR-3709 has nine VIDEO OUT terminals.

3. [ALL RESET] button

When the [ALL RESET] button is pressed, the digital video recorder is reset and the time is returned to its default setting.

4. AUDIO IN terminal

5. AUDIO OUT terminal

6. MIC IN terminal

7. MAIN MONITOR output terminal

8. MON2 output terminal

9. USB terminal

This terminal connects to a recordable CD-R/RW drive.

10. LAN terminal (10 Base-T or 100 Base-TX)

11. RS-485 termination switch

12. RS-485 terminal (A)

13. RS-485 terminal (B)

14. ALARM IN terminals

These terminals are used to activate alarm recording in response to operation of an alarm switch on a connected device.

The DSR-3709 has nine ALARM IN terminals.

Pin	Signal
C	Ground
ALARM IN 1 to 16	Alarm input No. 1 through No. 16

15. SENSOR ALARM OUT terminals

The terminals are used when motion sensors have been set (→P.81) to output an alarm signal to a connected device upon detection of motion.

The DSR-3709 has nine SENSOR ALARM OUT terminals.

Pin	Signal
C	Ground
SENSOR ALARM OUT 1 to 16	Output of an alarm signal for Camera No. 1 through No. 16

16. CONTROL terminals

Pin	Signal
C	Ground
REMOTE R1	Remote input 1
REMOTE R2	Remote input 2
CLOCK SET IN	Input of a clock setting signal from an external device
CLOCK SET OUT	Output of a clock setting signal to an external device
ALARM OUT	Total alarm output
ALARM RESET	Alarm reset input
WARNING OUT	Output of an HDD or FAN malfunction error
FULL	Capacity warning output for normal recording area space
ALARM FULL	Capacity warning output for alarm recording area space
SERIES IN	Signal input from an analog series connection
SERIES OUT	Signal output to an analog series connection
EXT TIMER IN	Signal input from an external timer
NON REC OUT	Non-recording output
C	Ground

17. Power socket (AC IN)

Insert the supplied power cable securely into this socket.

18. Power cord holder

Secure the power cord to the holder using the cord tie (accessory) as shown in the illustration.

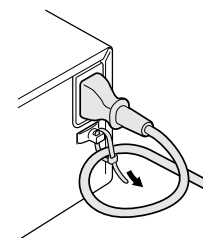

This section describes how to connect the digital video recorder to video cameras and other devices. Be sure to read the instruction manuals for each connected device.

CAUTION

- Improper connections can result in malfunction or the emission of smoke.
- A separate power supply is required for operation of each camera.

Basic connections

The following diagram shows the connections for cameras, monitors, a microphone, and a PC.

DSR-3716

The DSR-3709 can be connected to nine cameras.

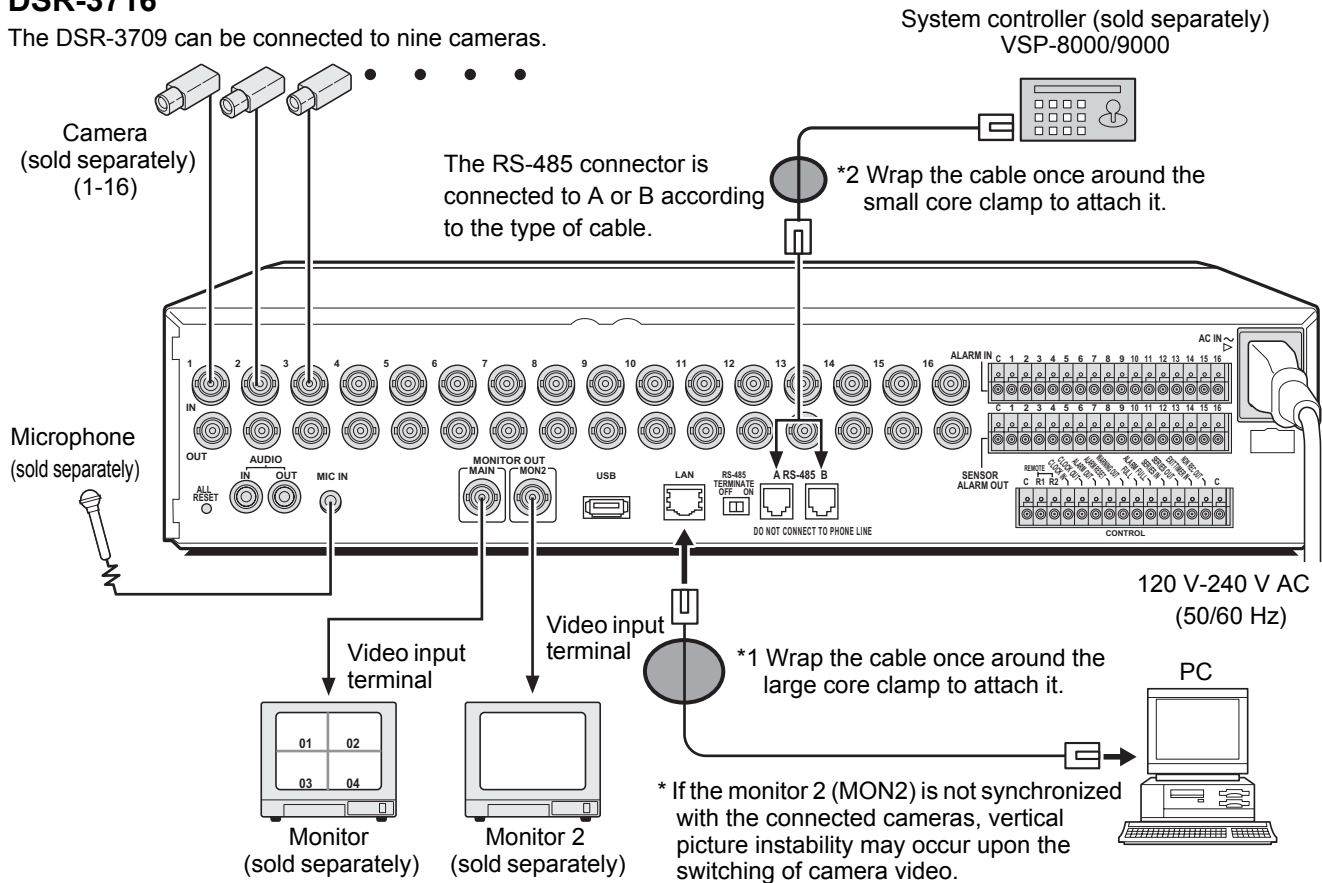

Connecting RS-485 terminals

The RS-485 terminals are used to connect a system controller (sold separately) to the digital video recorder. After connecting the system controller, you will need to carry out the settings that are given in the <RS-485 SET> menu. (→P.96)

Pin locations

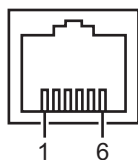

CAUTION

- Do not connect to phone line.

Pin number	Connector A signal	Connector B signal
1	Not used	Not used
2	Not used	Not used
3	A	B
4	B	A
5	Not used	Not used
6	Not used	Not used

A: Non-inverting driver output/receiver input
 B: Inverting driver output/receiver input

Connection

The digital video recorder supports both straight type and crossed type connection cables.

When using a straight type connection cable, connect the RS-485 connector's pin A to the pin A socket, or pin B to the pin B socket.

When using a crossed type connection cable, connect the RS-485 connector's pin A to the pin B socket, or pin B to the pin A socket.

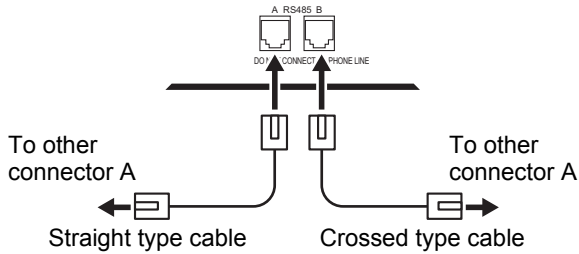

Cable types

Straight type:

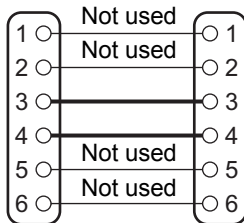

Crossed type:

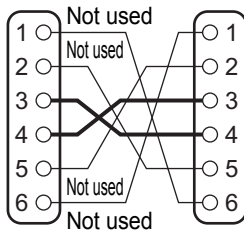

RS-485 termination switch settings

When connecting multiple devices, you must make termination settings on both end devices.

- Set the RS-485 termination switch of both end devices to ON.
- Be sure to set the RS-485 termination switches of all devices in between (devices other than the first and last devices) to OFF.

CAUTION

- If you don't make the correct termination settings, the incorrect data will be transmitted to each device.

Example

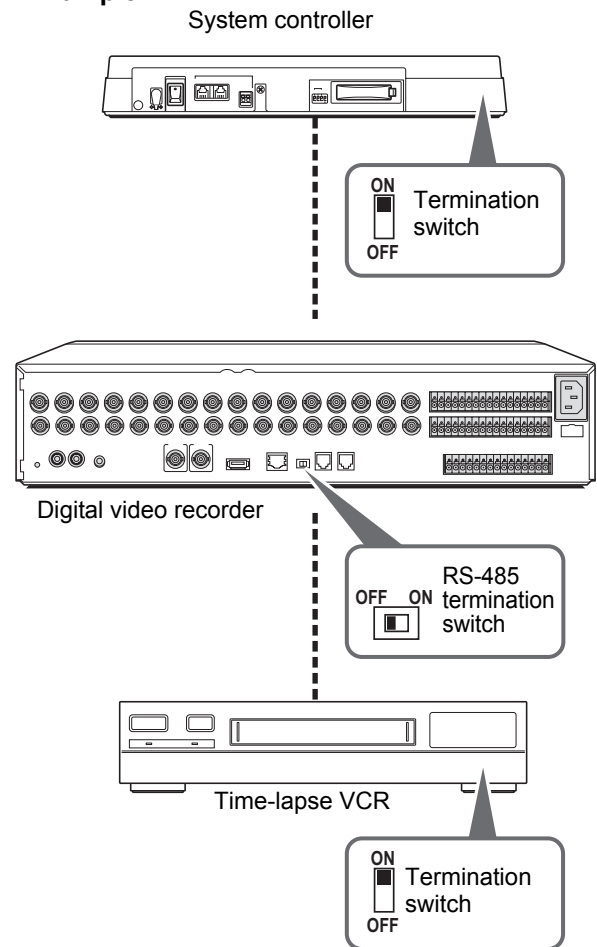

Connecting SANYO protocol devices (Dome Cameras)

Turn off all devices and use a coaxial cable to connect the devices.

NOTE

- Use the same procedure to connect using PELCO and BBV.

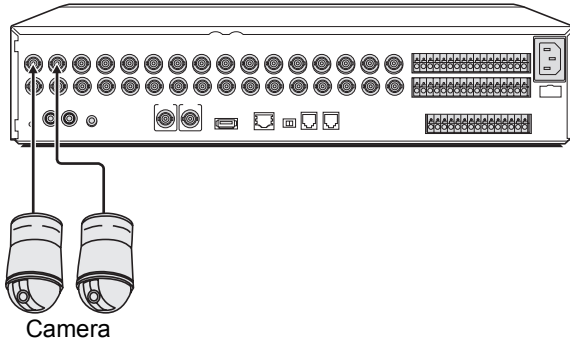

- 1 Connect cameras to the VIDEO IN terminals.
- 2 Set the protocols and address in the <CAMERA CONTROL SET> screen. (→P.97)
- 3 Operate the dome cameras with the front panel buttons. (→P.99)

Connecting an amplifier

An amplifier is connected when using a microphone or external speakers with the digital video recorder.

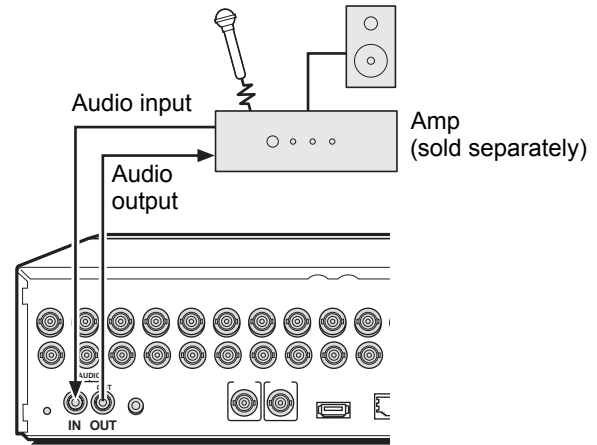

CAUTION

- Audio input from the AUDIO IN terminal and the MIC IN terminal cannot be performed simultaneously. If both terminals have devices connected, the MIC IN terminal is used.

Connecting ALARM IN terminals

When using external alarms (i.e., intruder sensors and the like), external switches are to be connected to the ALARM IN terminals.

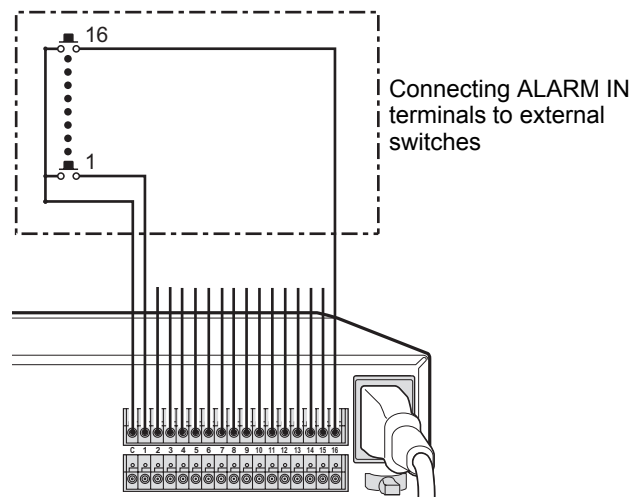

The DSR-3709 has nine ALARM IN terminals.

Connecting SENSOR ALARM OUT terminals

The SENSOR ALARM OUT terminals are used to relay alarm signals whenever one of the digital video recorder's motion sensors is triggered. Normally in an open condition, a terminal adopts low condition when a sensor for the corresponding camera number has been triggered.

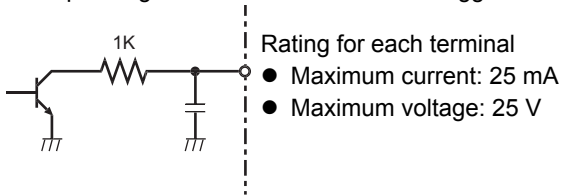

Connecting CONTROL terminals

The connections for a remote control circuit are shown below. This digital video recorder can be remotely controlled when a remote-control circuit similar to that shown here is connected to the remote-input control terminals.

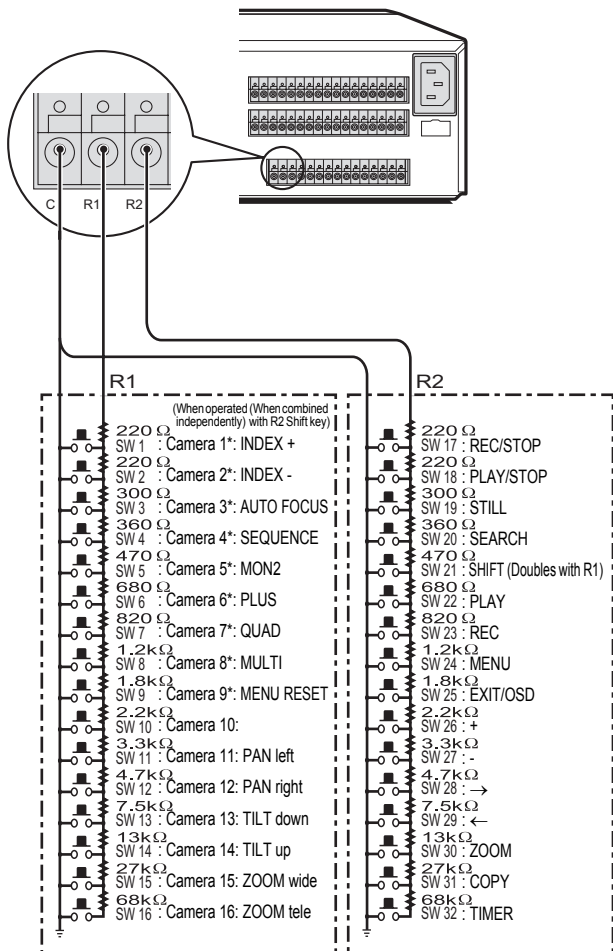

- Use a resistance of 1/10 ohms or more and with a D ranking (Precision within ±0.5%).
- The remote control cable should be no more than 5 m long.
- * The DSR-3709 can operate up to nine cameras (*).

Connecting the power cord

- 1 When you have finished making all the other connections, make sure the voltage is 120 V-240 V AC and insert the power plug into the wall outlet.

There is no power switch. The display indicators flash, and after a few moments, the monitor screen displays the camera image.

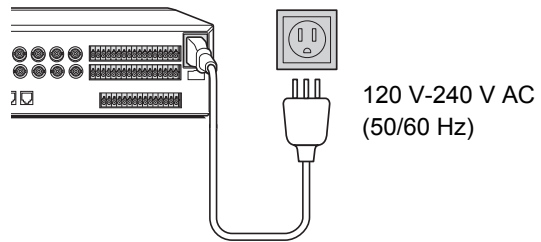

- When turning the power on for the first time "PLEASE SET THE CLOCK" is displayed on the monitor screen. Follow the procedures on P.17 to set the clock.
- If the clock is already set The operation display area is displayed.

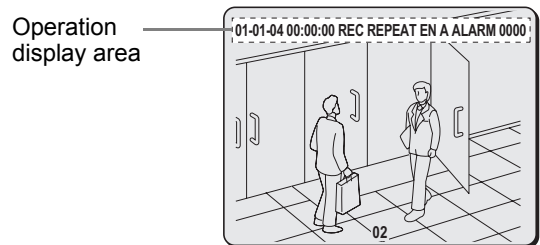

CAUTION

- If the POWER indicator starts flashing; If a problem occurs during use, the POWER indicator will begin to flash and an explanation will be displayed. In these cases, contact a Sanyo service center.

POWER indicator status	Meaning
Four flashes per second	There is a problem with the hard disk. The hard disk must be replaced or initialized. Contact a Sanyo service center to recover recorded images.
One flash per second	There is a problem with the fan.

- The power cord's ground terminal is not provided for enhanced safety; rather, it can be used to reduce the level of interference when the digital video recorder is connected to analog devices. If a large amount of noise is generated when the digital video recorder is connected to analog devices, connect this terminal to the building's earth.

Operation display area

Whenever the power is turned on, the operation display area will be shown at the top of the monitor screen. This area indicates the date, time, picture quality, and other information needed for operation.

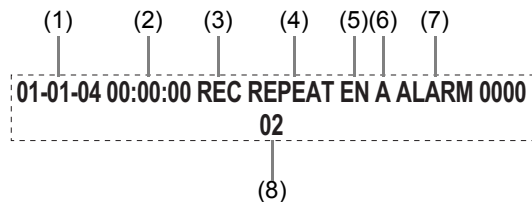

(1) Date display (→P.17)

"01-01-04" (month-day-year) is displayed when you turn the power on for the first time. Be sure to specify the correct date using menu settings.

(2) Time display (→P.17)

"00:00:00" is displayed when you turn the power on for the first time. The digital video recorder uses the date and time to manage recording and playback points. Accordingly, if the time has not been set correctly, you will not be able to effectively search for video data. Make sure to specify the time using menu settings. Recording will not be possible until a setting has been made.

(3) Operating symbol display

Displays the current operation (such as recording or playback).

REC: Recording ▶▶: Fast-forward playback
 EXT: External timer recording ◀◀: Fast-rewind playback
 ▶: Playback ||▶: Slow playback
 ◀: Reverse playback ◀||: Reverse slow playback
 ||: Still

NOTE

- During simultaneous recording and playback, the display indicates playback (▶).

(4) Remaining memory in recording area (→P.67)

Displays the remaining area memory as a percentage when overwriting in the normal recording area or the alarm recording area is forbidden. If overwriting has been permitted, "REPEAT" is displayed.

(5) Picture quality display (→P.71)

Displays the quality of the video that can be recorded on the hard disk. Set to "EN" (Enhanced) by default.

BA	Basic
NO	Normal
EN	Enhanced
FI	Fine
SF	Super Fine

(6) Audio recording display

"A" is displayed when audio is being recorded or played back.

(7) Alarm display and alarm count display (→P.77)

When you set an alarm using the "ALARM REC MODE SET" menu item, the alarm display area presents the following information.

- **When alarm recording is set;**
 "ALARM" is displayed.
 "ALARM" is flashed during alarm recording.
- **When pre-alarm recording is set;**
 "PRE" is displayed.
 When an alarm occurs, "PRE" disappears, "ALARM" is displayed, and the number of alarms is shown. The total number is indicated in the alarm display.
- **When performing playback from the archive area;**
 "ARCHIV" is displayed.
- **When an external alarm signal is activated;**
 "EA" is flashed to the left of the camera number.
- **When a motion sensor alarm signal is activated;**
 "SA" is flashed to the left of the camera number.
- **When an external alarm signal and motion sensor signal are activated;**
 "ES" flashes to the left of the camera number.

(8) Camera title display

The camera number or camera title is displayed. In addition, when an alarm occurs, the camera number and alarm "EA", "SA" or "ES" are displayed along with the camera title.

- **During video loss;**
 The display alternates between showing the camera title and "VIDEO LOSS". "VIDEO LOSS" flashes when the operating display is hidden. (→P.16)
- **During no video signal;**
 "NO VIDEO" is displayed in place of the camera title.

NOTE

- Although operations such as playback, copying, and data transfer are possible while recording, this unit gives priority to recording, and other operations may be delayed as a result.

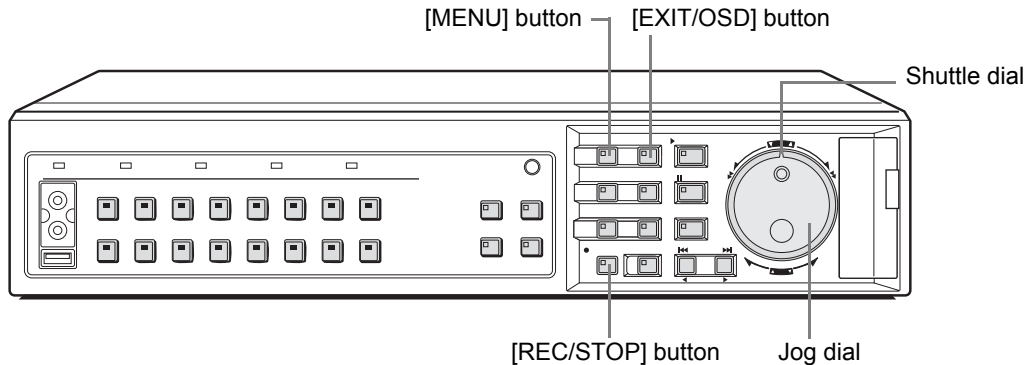

Changing the position of the operation display area

1 Press the [EXIT/OSD] button.

As the [EXIT/OSD] button is pressed, the operation display area moves to a different location or is hidden.

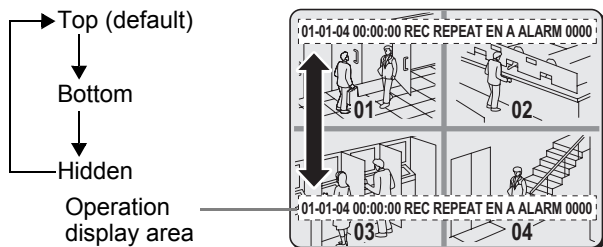

Changing the language

Use the following procedure to set the language displayed on the monitor.

[Settings] (◆ indicates default setting)

Item	Setting	Description
LANGUAGE	◆ ENGLISH	Sets the language to English.
	FRANCAIS	Sets the language to French.
	ESPAÑOL	Sets the language to Spanish.

1 Press the [MENU] button.

The MENU indicator lights up and the <MAIN MENU> is displayed.



2 Turn the shuttle dial clockwise.

The <INITIAL SET> screen is displayed.

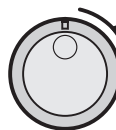

3 Turn the shuttle dial clockwise.

The cursor moves to "ENGLISH".



4 Turn the shuttle dial clockwise, and then turn the jog dial to select the desired language.

The set item flashes.

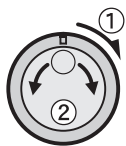

5 When you have made a selection, turn the shuttle dial clockwise.

The cursor moves to the date and time.

The language has now been set.

To return to the normal screen, press the [EXIT/OSD] button.

EXIT/OSD



Setting the time

(Default: 01-01-2004 THU 00:00:00)

Be sure to set the correct date and time as these settings are used during recording and searching.

Example: Setting 8:30 on October 26, 2004

1 Press the [MENU] button.

The MENU indicator lights up and the <MAIN MENU> is displayed.

MENU



2 Turn the shuttle dial clockwise.

The <INITIAL SET> screen is displayed.

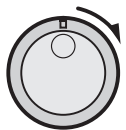

3 Turn the shuttle dial clockwise.

The <LANGUAGE/LANGUE/IDIOMA> screen is displayed.

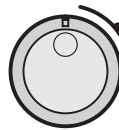

4 Turn the jog dial to select the date and time for <CLOCK SET> and turn the shuttle dial clockwise.

"01" flashes (indicating the month).



5 Set "10" with the jog dial or numeric keys and turn the shuttle dial clockwise.

"01" flashes (indicating the day).



6 Use the same procedure to set the day (26), year (2004), hour (08), and minute (30).

When you have set the minute, the cursor moves to "MODE" under <DAYLIGHT SAVING>, and the clock starts counting from 00 seconds.

- The week day is set automatically.
- The clock is stopped during date and time settings.

7 Press the [EXIT/OSD] button.

The setting procedure is ended and the display returns to the normal screen.

EXIT/OSD



The internal hard disk

<RECORDING AREA SET>	
	TOTAL CAPACITY : 82GB
[A]	NORMAL RECORDING AREA : 80 %
	AREA FULL RESET ->
[B]	ALARM RECORDING AREA : 19 %
	AREA FULL RESET ->
[C]	ARCHIVE AREA : 1 %
	AREA FULL RESET ->
CAUTION : WHEN THE AREA SETTING IS CHANGED, THE WHOLE AREA WILL BE INITIALIZED !	

Hard disk recording areas

When the digital video recorder is turned on, recording areas are automatically setup within the internal hard disk (with the default settings being normal recording area: 80%, alarm recording area: 19%, and archive area: 1%). When the [REC/STOP] button is pressed, this digital video recorder starts recording video data in the normal recording area. When an alarm occurs, the corresponding video data is recorded in the alarm recording area.

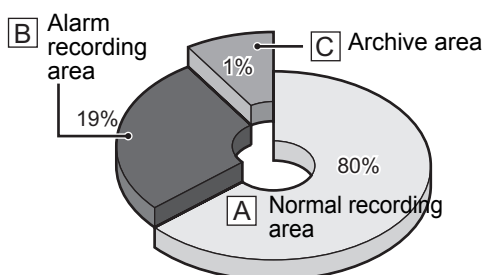

Hard Disk Recording Areas

[A] Normal recording area

Recording mode	Recording method	
Normal recording	Manual	When monitoring, recording is performed in response to pressing of the [REC/STOP] button.
Timer recording	Automatic	Recording is carried out in accordance with timer settings.

[B] Alarm recording area

Recording mode	Recording method	
Alarm recording	Automatic	Recording is carried out when alarm recording is set to "ENABLED". Specifically, alarm images are recorded in the alarm recording area in response either to operation of a switch that has been connected to an alarm input terminal or to detection of an intruder or the like using motion sensors.
Pre-alarm recording	Automatic	When pre-alarm recording is set to "ON", it will be possible to record video from before the occurrence of an alarm based on the corresponding settings.

[C] Archive area

Recording mode	Recording method	
Copy	Manual	This area is used to store important video data copied from the normal recording area and/or alarm recording area. By making changes to the normal recording area and the alarm recording area, this area can be extended to up to 10 GB in size (i.e., 12% when using a 80 GB hard disk).

! CAUTION

- If the memory allocations for the various hard disk recording areas are changed during a recording process, all stored recordings will be deleted and the hard disk will be initialized; accordingly, special care should be taken. For more details, refer to P.65.
- In the case of certain hard disks, error may be present in the total hard disk capacity as displayed on menu screens.

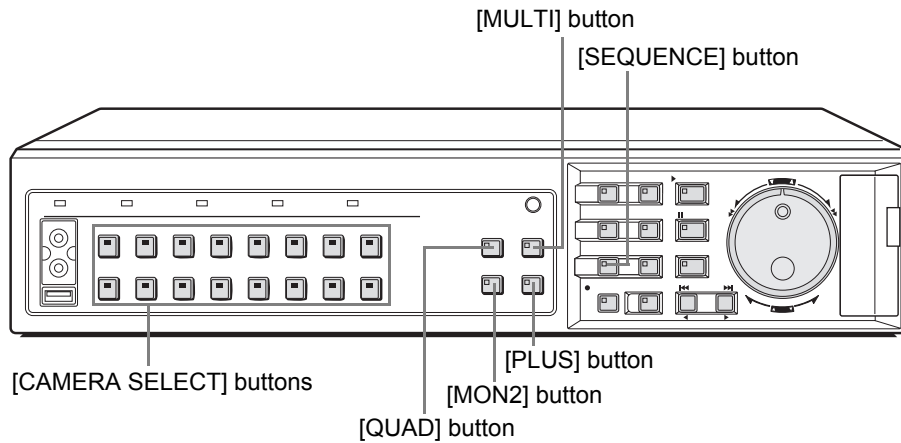

Viewing on a full screen

Example: Selecting Camera 2

- 1 Press the No. 2 [CAMERA SELECT] button.

The No. 2 CAMERA SELECT indicator lights up and video from Camera 2 is displayed on a full screen.

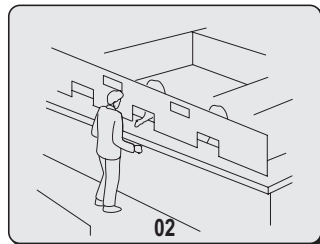

Viewing enlarged live images

Images can be enlarged while monitoring on a full screen. Operations are the same as "Enlarging the playback video". See P.27 for more details.

Viewing on quad screens

Images from multiple connected cameras can be displayed simultaneously.

- 1 Press the [QUAD] button.

The QUAD indicator lights up and video from four separate cameras is displayed simultaneously.

Video from Camera No. 1 through Camera No. 4 is displayed.

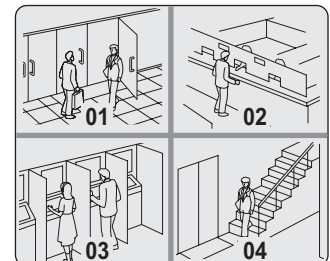

- 2 To view video from other cameras, press the [QUAD] button again.

Each time this button is pressed, the four images on the quad screen change, in order of cameras No. 1-4, 5-8, 9-12 and 13-16.

On the DSR-3709, the images change in order of cameras No. 1-4, 5-8, 9-3, etc.

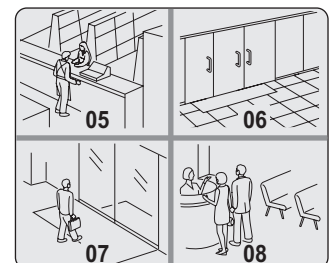

- 3 To return to full screen display, press the [CAMERA SELECT] button.

Viewing on multi screens (9 screens/16 screens)

1 Press the [MULTI] button.

The MULTI indicator lights up and video from nine separate cameras is displayed simultaneously. Press the [MULTI] button again to display video from 16 cameras. The DSR-3709 can only display video from nine cameras.

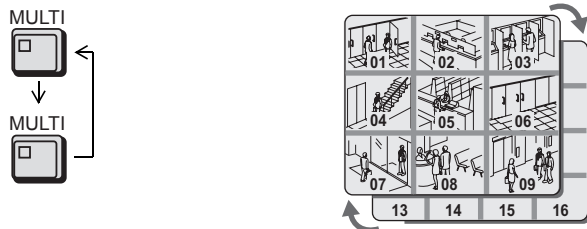

NOTE

- For both quad and multi 9/16 screen display, display positions can be changed. (→P.100)

2 To return to full screen display, press the [CAMERA SELECT] button.

Viewing on plus screen

Enlarge one camera video to quad screen size to view in multi 6/13 screen display.

For DSR-3709, this operation is available only when in multi 9 screen display.

1 Press the [PLUS] button.

PLUS indicator lights and one camera image is enlarged.

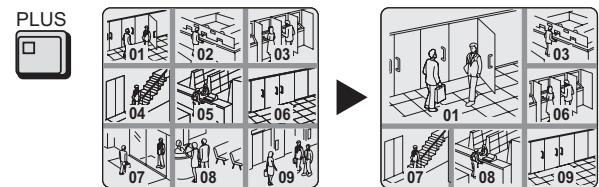

2 Press the corresponding [CAMERA SELECT] button to change enlarged camera image.

The video from the selected camera is enlarged.

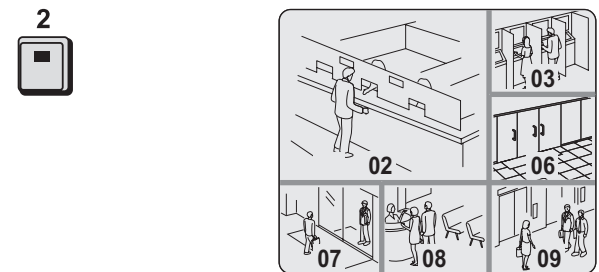

3 Press [MULTI] button to switch from multi 6 screen display to multi 13 screen display.

Operation can be performed solely with DSR-3716.

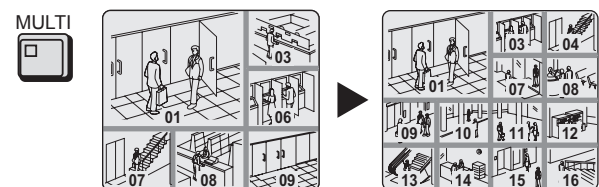

4 Press [PLUS] button to return to the previous display.

! CAUTION

- The time required for updating differs for each image.

Viewing with automatic screen selection

Setting automatic full screen selection

Use the following procedure when viewing a full screen to have the displayed video change automatically based on camera numbers.

1 Press the [SEQUENCE] button.

The SEQUENCE indicator starts to flash and the displayed video changes automatically based on camera numbers.

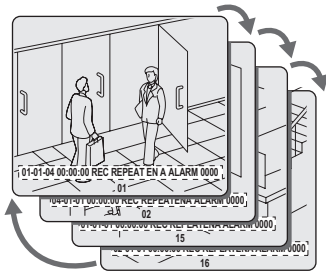

NOTE

- It is possible to specify the cameras for which automatic selection is to be carried out. (→P.102)

Canceling automatic selection

2 Either press the [SEQUENCE] button once again or press the appropriate [CAMERA SELECT], [QUAD], or [MULTI] button.

Automatic selection ends and the display returns to the normal screen.

Setting automatic quad-screen selection

1 Press the [QUAD] button.

The QUAD indicator lights up and the monitor display is divided in four.

QUAD

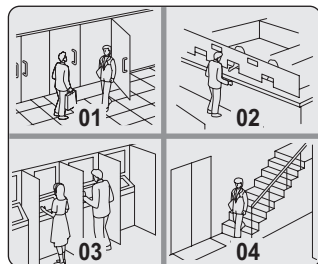

2 Press the [SEQUENCE] button.

The content of the split screen will automatically toggle between video from cameras No. 1 through No. 4 and video from cameras No. 5 through No. 8, No. 9 through No. 12 and No. 13 through No. 16

On the DSR-3709, the video changes automatically in order of cameras No. 1-4, 5-8, 9-3, etc.

SEQUENCE

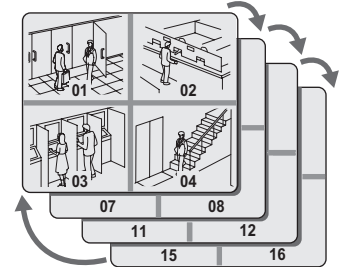

Returning to normal quad-screen display

3 Press the [SEQUENCE] button once again.

Automatic selection ends and normal quad-screen display returns.

! CAUTION

- Automatic selection cannot be used with playback video.

Viewing on the monitor 2

When a monitor 2 is connected to the monitor 2 output terminal on the digital video recorder's rear panel, this monitor can be used to view video from a single camera or to automatically scroll through video from all cameras, even if the main monitor is currently displaying video in split-screen format. In addition, it is also possible to display video on the monitor 2 automatically from any camera for which an alarm has occurred. By default, automatic full screen selection is carried out.

Change the monitor 2 setting

1 Press the [MON2] button.

The MON2 indicator lights up.

MON2

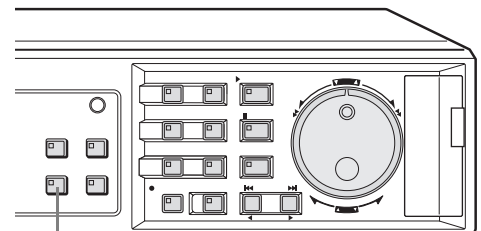

[MON2] button

! CAUTION

- Monitor 2 operation is not possible when a menu screen is being displayed.
- As the [EXIT/OSD] button is pressed, the operating display moves to a different location or is hidden in the same manner as the main monitor. (→P.16)

Selecting Camera No. 4 for full screen**2 Press the No. 4 [CAMERA SELECT] button.**

The video from Camera No. 4 is displayed in full screen format on the monitor 2.

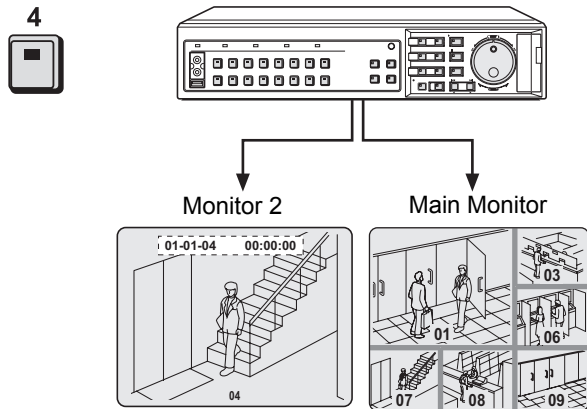
**Setting automatic full screen selection****1 Press the [SEQUENCE] button.**

The video displayed on the monitor 2 changes automatically based on camera numbers. Press the [SEQUENCE] button once again to cancel automatic selection.

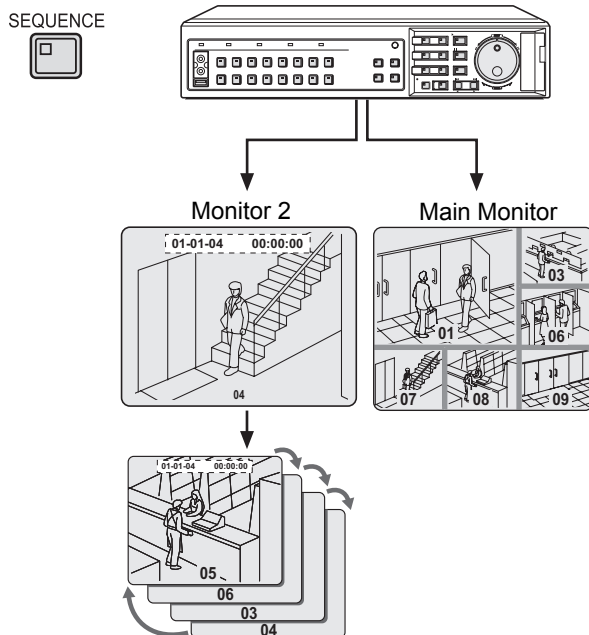
**! CAUTION**

- If the monitor 2 is not synchronized with the connected cameras, vertical picture instability may occur upon the switching of camera video.

Displaying alarm video in full screen format**1 Set "MON.2 DISPLAY" from <ALARM OPERATION SET> to "ON". (→P.84)**

When an alarm occurs, the corresponding video is displayed in full screen format on the monitor 2.

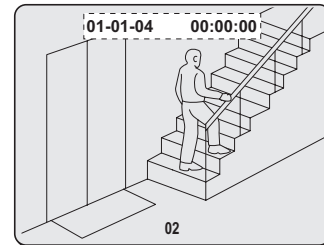
**Ending the monitor 2 setting procedure****1 Press the [MON2] button.**

The MON2 indicator turns off.

**! CAUTION**

- Playback video cannot be viewed on the monitor 2.

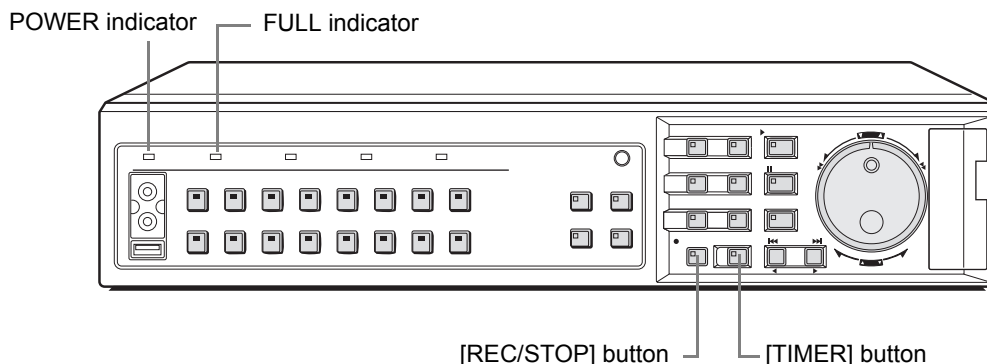

Normal recording

Use the following procedure to record the monitored video in the normal recording area.

Recording will not be possible until a time has been set for the digital video recorder. Make sure to set the time. (→P.17)

1 Press the [REC/STOP] button.

The REC/STOP indicator lights up, “REC” appears on-screen (i.e., the recording symbol), and recording starts.



NOTE

- When recording for the first time, the default settings are used. For details regarding modification of the picture quality or recording rate, see P.71.
- When the space remaining in the normal recording area drops below a preset value, the FULL indicator on the digital video recorder's front panel starts to flash. If recording is continued beyond this point, the normal recording area will become full, recording will stop, and the FULL indicator will stop flashing and remain lit. In such a case, use the <RECORDING AREA SET> screen to perform “AREA FULL RESET” for the normal recording area, thus allowing recording to start again from the beginning. (→P.67)
- Playback is possible even while recording. See P.26 for more details.

Ending normal recording

2 Press and hold the [REC/STOP] button for approximately 3 seconds.

“REC” disappears from the operation display and recording ends.



Timer recording

Use the following procedure to record the monitored video for a preset length of time in the normal recording area. Recording will not be possible until a time has been set for the digital video recorder. Make sure to set the time. (→P.17)

1 Press the [TIMER] button.

The TIMER indicator lights up and the digital video recorder enters timer recording standby mode.

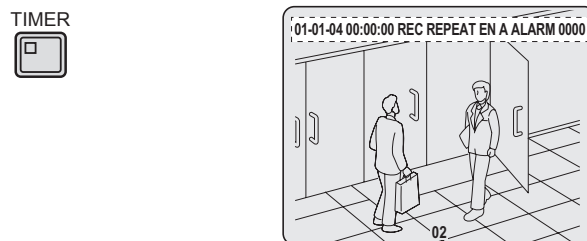

- (1) See P.74 for more details on timer recording settings.
- (2) At the time specified for the start of timer recording, the REC/STOP indicator lights up, “REC” appears on-screen (i.e., the recording symbol), and recording starts.
- (3) At the time specified for the end of timer recording, the REC/STOP indicator turns off, and recording ends. The [TIMER] button remains lit up.

NOTE

- When the space remaining in the normal recording area drops below a preset value, the FULL indicator on the digital video recorder's front panel starts to flash. If recording is continued beyond this point, the normal recording area will become full, recording will stop, and the FULL indicator will stop flashing and remain lit. In such a case, use the <RECORDING AREA SET> menu to perform “AREA FULL RESET” for the normal recording area, thus allowing recording to start again from the beginning. (→P.67)
- Playback is possible even while recording. See P.26 for more details.

Stopping timer recording before completion

2 Press the [TIMER] button.

The TIMER indicator turns off and recording ends.



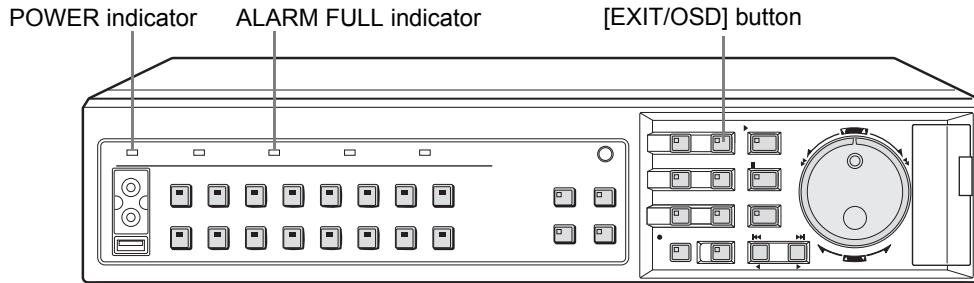

Alarm recording

Use the following procedure to automatically record alarm video to the alarm recording area when an alarm signal is detected.

Recording will not be possible until a time has been set for the digital video recorder. Make sure to set the time. (→P.17)

1 Set alarm recording.

Follow the instructions on P.77 to set “7. ALARM REC MODE SET” from <RECORD SET>.

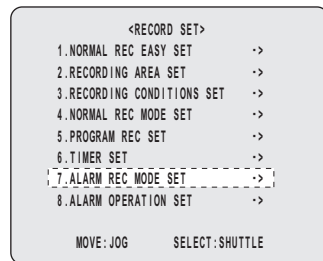

2 Press the [EXIT/OSD] button.

The setting procedure is ended and the display returns to the normal screen.



When an alarm signal is detected

- When an alarm signal is detected, “ALARM” flashes in the operation display and the alarm recording starts (indicated by “REC”).
- Alarm video is recorded to the alarm recording area.
- Whenever an alarm occurs, the number of alarms as indicated in the operation display is incremented.

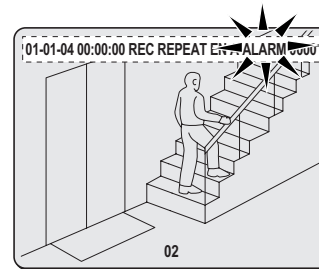

Counts the number of alarms. Values between 0000 and 9999 can be displayed.

- If an alarm occurs during normal recording or timer recording, the recording operation will be cancelled.
- A maximum of 16,000 alarm recordings can be made on one hard disk. If hard disk expansion is carried out, this number can be increased to 32,000. Note, however, since settings for each condition will affect the maximum number of recordings that can be made, be sure to check menu settings and display content.

3 End alarm recording.

When the alarm duration has expired (default setting: 20 seconds), both “REC” and “ALARM” finish flashing from the operation display and recording stops.

NOTE

- When the space remaining in the alarm recording area drops below a preset value, the ALARM FULL indicator on the digital video recorder’s front panel starts to flash. If recording is continued beyond this point, the alarm recording area will become full, recording will stop, and the ALARM FULL indicator will stop flashing and remain lit. In such a case, use the <RECORDING AREA SET> menu to perform “AREA FULL RESET” for the alarm recording area, thus allowing recording to start again from the beginning. (→P.67)
- When normal recording area is set to “*0%,” alarm recording can be executed as long as there is remaining space on the hard disk. More than 16,000 alarm recordings can be recorded on each hard disk. (→P.65)

Pre-alarm recording

Use the following procedure to record video from immediately before occurrence of an alarm.

1 Set pre-alarm recording.

Follow the instructions on P.79 set "7. ALARM REC MODE SET" from <RECORD SET> to "PRE-ALARM RECORDING".

<ALARM REC MODE SET>	
ALARM RECORDING	: ENABLED
PICTURE QUALITY	: ENHANCED
AUDIO RECORDING	: ON
ALARM INTERLEAVE	: ONLY
REC RATE: A	15FPS, DURATION: 20SEC
PRE-ALARM RECORDING	: ON
REC RATE: A	15FPS, DURATION: 1MIN
=> (00371 ALARMS CAN BE RECORDED)	
ALARM TRIGGER	: ALARM
MOTION SENSOR	: ->

2 Press the [EXIT/OSD] button.

The setting procedure is ended and the display returns to the normal screen.

"PRE" appears in the operation display area. Pre-alarm recording starts (without the "REC" symbol being displayed).

EXIT/OSD

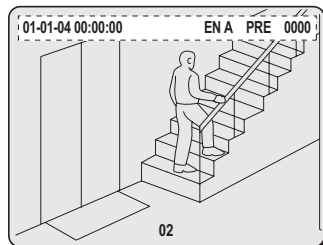

If an alarm is detected

Pre-alarm recording is automatically ended and alarm recording starts.

- "PRE" from the operation display area is replaced by "ALARM", and "ALARM" starts to flash.

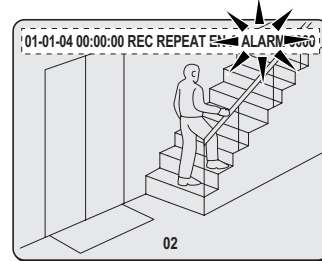

NOTE

- When recording for the first time, the default settings are used. For details regarding modification of the picture quality or recording rate, see P.71.
- When the space remaining in the alarm recording area drops below a preset value, the ALARM FULL indicator on the digital video recorder's front panel starts to flash. If recording is continued beyond this point, the alarm recording area will become full, recording will stop, and the ALARM FULL indicator will stop flashing and remain lit. In such a case, use the <RECORDING AREA SET> menu to perform "AREA FULL RESET" for the alarm recording area, thus allowing recording to start again from the beginning. (→P.67)

ALARM FULL indicator

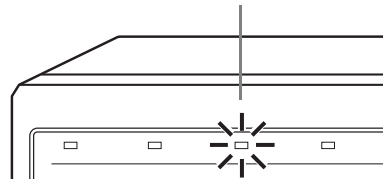

Use the following procedure to play video stored in the normal recording area (during normal or timer recording).

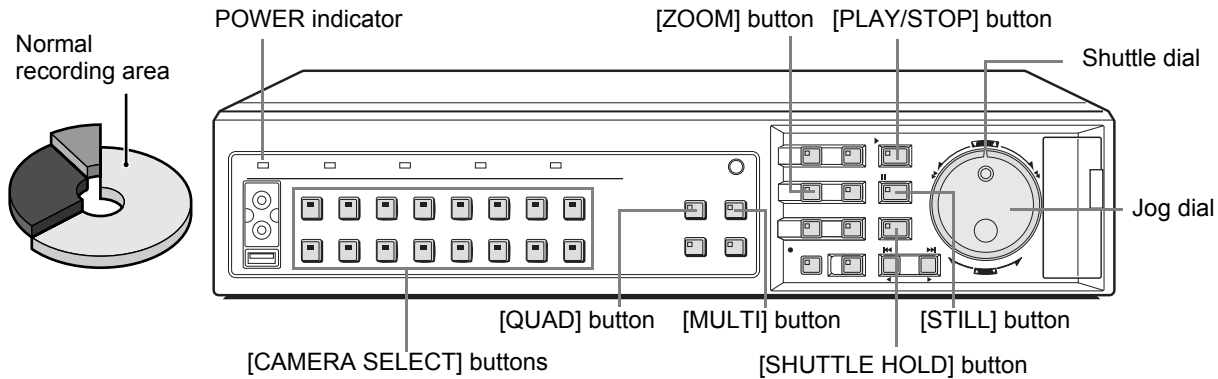

Playing video on a full screen

1 Press the [PLAY/STOP] button.

The PLAY/STOP indicator lights up, and “▶” appears in the operation display area. Video stored in the normal recording area is played back. Use the appropriate [CAMERA SELECT] button to select the camera whose video is to be played.

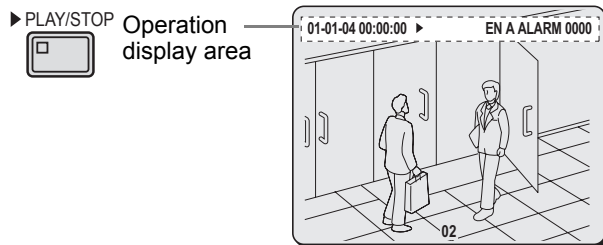

NOTE

- Video playback begins at the start point of recording.
- If the start point of recording has been cleared or reset, video playback will start from the earliest recording.
- When playback ends, the digital video recorder pauses automatically.
The operation display area indicates that playback is paused (using “||”), and the STILL indicator lights.
- After being paused or stopped, playback resumes from the stop point.

Ending playback

2 Press the [PLAY/STOP] button.

Playback ends.



■ Playing video near the point of recording

The digital video recorder prioritizes recording operations, and as a result, video playback may pause temporarily.

Fast-forward and fast-rewind playback

1 Turn the shuttle dial clockwise or counter-clockwise during video playback.

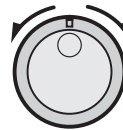

When turned clockwise, the symbol “▶▶” appears in the operation display area and fast-forward playback is started.

When turned counter-clockwise, the symbol “◀◀” appears in the operation display area and fast-rewind playback is started.

Normal playback is resumed when you release the shuttle dial.

NOTE

- If the [SHUTTLE HOLD] button is pressed while the shuttle dial is being turned and either “◀◀” or “▶▶” is displayed, the speed of fast-rewind or fast-forward playback will be maintained even after the dial is released.

Changing the playback speed

Starting fast-forward or slow playback

(1) Performing fast-forward.



When the jog dial is turned clockwise, fast-forward playback is started and the symbol “▶▶” appears in the operation display area.

(2) Performing slow playback.



When the jog dial is turned counter-clockwise, slow playback is started and the symbol “◀◀” appears in the operation display area.

(3) Returning to normal playback.



Turn the jog dial slightly clockwise to display “▶”.

! CAUTION

- Audio will not be played during fast-forward, fast-rewind, slow, reverse-slow, and reverse playback.

Starting fast-rewind or reverse-slow playback

(1) Turn the shuttle dial counter-clockwise to display “◀” in the operation display area.



Reverse playback starts at the same speed as normal playback.



Press the [SHUTTLE HOLD] button while “◀” is being displayed. The SHUTTLE HOLD indicator lights up, and even if the shuttle dial is now released, reverse playback continues at the current speed.

- Turn the jog dial counter-clockwise.



“◀◀” appears in the operation display area and the speed of reverse playback increases.

- Turn the jog dial clockwise.



“◀◀” appears in the operation display area and the speed of reverse playback decreases.

(2) Returning to normal playback.



Press the [SHUTTLE HOLD] button to turn off SHUTTLE HOLD indicator. Turn the shuttle dial either clockwise or counter-clockwise to display “▶” in the operation display area. Normal video playback is restored.

Enlarging the playback video

1 Press the [ZOOM] button during playback or monitoring of camera video.

ZOOM indicator lights and a zoom frame appears in the center of the screen.

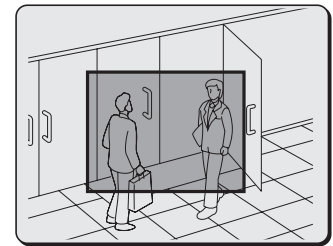

2 Move the zoom frame to the area to be magnified.

- Turn the jog dial clockwise to move the zoom frame to the right. Turn the jog dial counter-clockwise to move the zoom frame to the left.

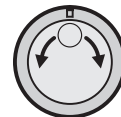

- Turn the shuttle dial clockwise to switch to vertical movement.

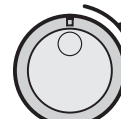

- Now, when the jog dial is turned clockwise, the zoom frame moves down; when turned counter-clockwise, the zoom frame moves up.

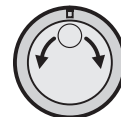

- In this way, move the zoom frame to enclose the area of video to be magnified.

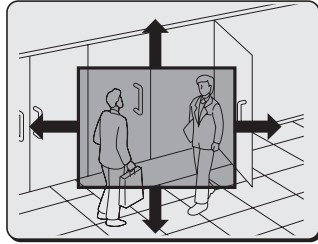

3 Turn the shuttle dial clockwise.

The area enclosed by the zoom frame is magnified (by a factor of 2).

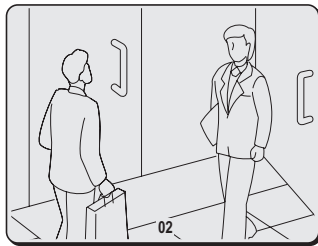

Returning to normal magnification

4 Press the [ZOOM] button.

Magnification is cancelled and the display returns to the normal screen. ZOOM indicator turns off.

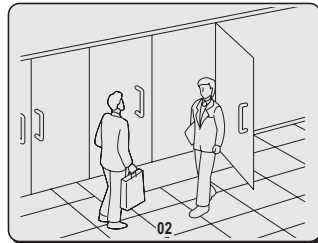

NOTE

- Magnification is not possible on monitor 2 or during quad screen, multi-screen (9 screens/ 16 screens), or plus screen display.

! CAUTION

- Magnified video has a slightly coarser appearance when compared with normal video.

Viewing still images

1 Press the [STILL] button during playback.

The STILL indicator lights up and playback video is paused. The symbol "||" appears in the operation display area.



To resume playback

2 Press the [STILL] button once again.

Normal playback is restored.



Performing frame advance (forward or reverse)

1 Turn the jog dial clockwise or counter-clockwise while playback is paused.

Clockwise: The still image is moved forward by one frame or field.

Counter-clockwise: The still image is moved back by one frame or field.



NOTE

- The jog dial can be turned to increase the speed of frame advance.

CAUTION

- When the images from normal recording area and alarm recording area are played back in succession, the quality of the picture may drop momentarily as playback switches from one recording area to another.
- If normal, fast-forward, or fast-rewind playback is carried out either for playback during alarm recording or for continuous playback from the normal recording area and alarm recording area, the image may seem to have paused in certain cases.

Playing video on multiple screens

If you are recording video from a number of different cameras, the following procedures can be used to play the recorded video in multi-screen format.

Playing video on quad screens

1 Press the [QUAD] button during playback.

The QUAD indicator lights up and the monitor display is divided in four.

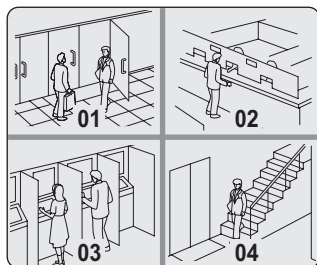

2 Press the [QUAD] button.

Each time this button is pressed, the content of the split screen will toggle between video from cameras No. 1 through No. 4 and video from cameras No. 5 through No. 8, No. 9 through No. 12 and No. 13 through No. 16.

On the DSR-3709, the images change in order of cameras No. 1-4, 5-8, 9-3, etc.

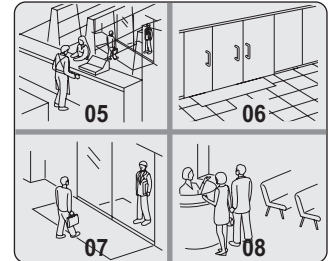

■ Returning to full screen display

Press the [CAMERA SELECT] button.

Playing video on multi 9 or multi 16 screens

1 Press the [MULTI] button.

The MULTI indicator lights up and video from nine separate cameras is displayed simultaneously. Press the [MULTI] button again to display video from 16 cameras. The DSR-3709 can only display video from nine cameras at a time.

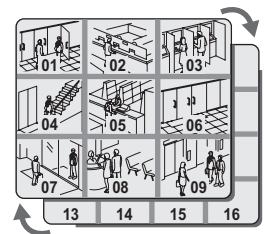

■ Returning to full screen display

Press the [CAMERA SELECT] button.

NOTE

- In the case of quad, multi 9 and 16 screen display you can change the position in which playback video is displayed. (→P.100)

Images stored in the normal recording area, alarm recording area or archive area can be located by searching and can then be played back. Use one of the following five search methods to locate the required video.

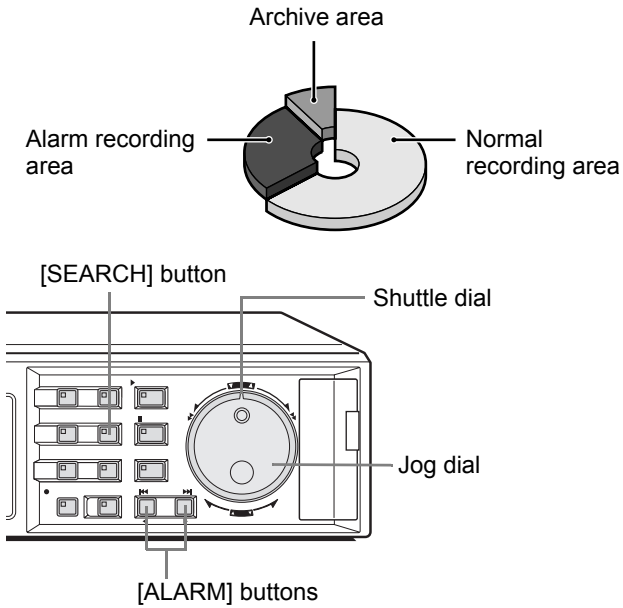

Searching from the <SEARCH> screen

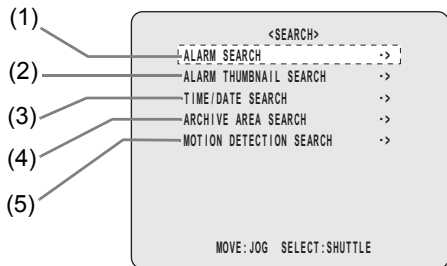

NOTE

- During the playback of video, you can use the front-panel buttons, the shuttle dial, and the jog dial to perform operations such as pause and fast-forward.

CAUTION

- Search is unavailable during playback or menu display.

(1) ALARM SEARCH (→P.31)

Lets you search and playback alarm video from the recording list.

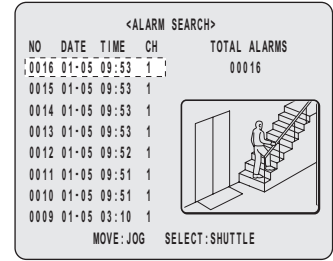

(2) ALARM THUMBNAIL SEARCH (→P.32)

Lets you search and playback alarm video using a thumbnail list.

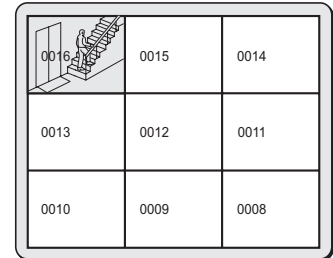

(3) TIME/DATE SEARCH (→P.32)

Lets you search and playback recorded video based on date and time.

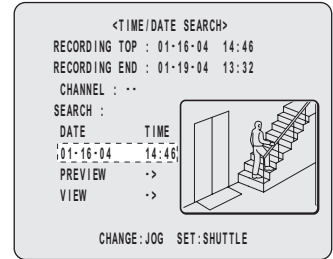

(4) ARCHIVE AREA SEARCH (→P.34)

Lets you playback video that has been stored in the archive area.

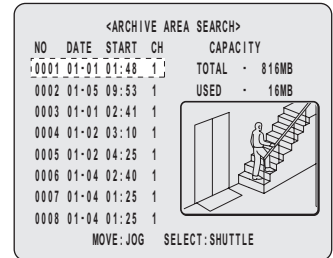

(5) MOTION DETECTION SEARCH (→P.34)

Lets you search and playback video of moving objects detected by motion sensors.

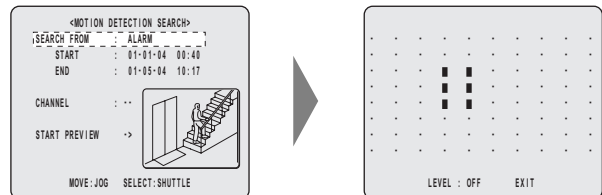

Alarm search

Use the following procedure to search and playback all video stored in the alarm recording area. If pre-alarm video is being recorded, playback will start from immediately before the alarm.

1 Press the [SEARCH] button while the digital video recorder is recording or stopped.

The SEARCH indicator lights up and the <SEARCH> screen is displayed.



2 Turn the jog dial to select "ALARM SEARCH", and then turn the shuttle dial clockwise.

The <ALARM SEARCH> screen is displayed.
The eight most-recent alarm recordings are displayed.

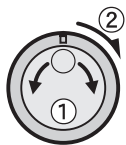

(1) NO	(2) DATE	(3) TIME	CH	(4) TOTAL ALARMS
<ALARM SEARCH>				
0016	01-05	09:53	1	00016
0015	01-05	09:53	1	
0014	01-05	09:53	1	
0013	01-05	09:53	1	
0012	01-05	09:52	1	
0011	01-05	09:51	1	
0010	01-05	09:51	1	
0009	01-05	03:10	1	

MOVE: JOG SELECT: SHUTTLE

- (1) **NO:**
Indicates the alarm number.
- (2) **DATE/TIME:**
Indicates the date and time at which the alarm video was recorded.
- (3) **CH:**
Indicates the alarm video's channel (or camera number).
- (4) **TOTAL ALARMS:**
Indicates the total number of alarm video recordings.
- (5) **Preview:**
Displays the selected alarm video.

3 Turn the jog dial to select the video for playback.

A preview of the selected alarm video is displayed in the preview screen. In this case, the video from the instant of alarm occurrence is displayed.



- **To display the next or previous recording**
Turn the jog dial clockwise or counter-clockwise accordingly.

NOTE

- **To leave search mode**
Press the [SEARCH] button. SEARCH indicator turns off.

4 Turn the shuttle dial clockwise.

The selected recording is played back in full screen mode.

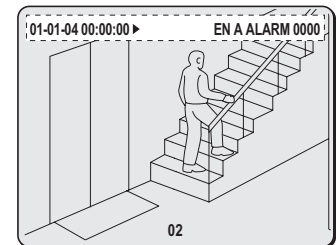

■ To view pre-alarm video

After beginning playback of an alarm recording identified by an alarm search, use the shuttle dial to reverse playback.

To view alarm video before or after the current playback

1 Press the appropriate [ALARM] button during playback.

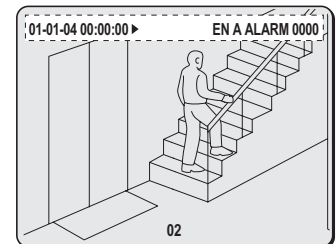

- Each time the "◀◀" button is pressed, playback will skip to the preceding alarm video recording.
- Each time the "▶▶" button is pressed, playback will skip to the subsequent alarm video recording.

NOTE

- When playback is performed after an alarm search, the frame at the start and end of each alarm recording will be paused. Press the appropriate [ALARM] button to play the previous or next alarm recording.
- You can use the front-panel buttons, the shuttle dial, and the jog dial to perform operations such as pause and fast-forward.

Alarm thumbnail search

Use the following procedure to display all of the alarm recordings stored in the alarm recording area as thumbnails list.

1 Press the [SEARCH] button while the digital video recorder is recording or stopped.

The SEARCH indicator lights up and the <SEARCH> screen is displayed.

SEARCH



2 Turn the jog dial and select "ALARM THUMBNAIL SEARCH".



3 Turn the shuttle dial clockwise.

The nine most-recent alarm recordings are displayed. An alarm number is indicated together with each alarm recording, and the number of the currently selected recording will flash.

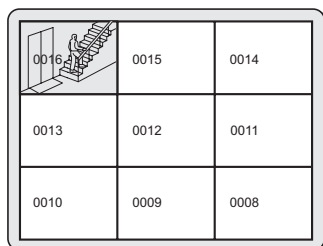

4 Turn the jog dial to select the alarm recording for playback.

The alarm number for the selected recording will start to flash.

- **To display the next or previous recording**
Turn the jog dial clockwise or counter-clockwise accordingly.

NOTE

- **To leave search mode**
Press the [SEARCH] button. SEARCH indicator turns off.

5 Turn the shuttle dial clockwise.

The selected recording is played back in full screen mode.



■ To view pre-alarm video

After beginning playback of an alarm recording identified by an alarm search, use the shuttle dial to reverse playback.

! CAUTION

- In the same way as for alarm searching, playback is only possible within each individual alarm recording. Press the appropriate [ALARM] button to play the previous or next recording.
- You can use the front-panel buttons, the shuttle dial, and the jog dial to perform operations such as pause and fast-forward.

Time/date search

Use the following procedure to play a recording from the normal recording area (i.e., a normal recording or timer recording) or alarm recording area by specifying its date and time.

1 Press the [SEARCH] button while the digital video recorder is recording or stopped.

The SEARCH indicator lights up and the <SEARCH> screen is displayed.

SEARCH



2 Turn the jog dial to select "TIME/DATE SEARCH".



3 Turn the shuttle dial clockwise.

The <TIME/DATE SEARCH> screen is displayed.

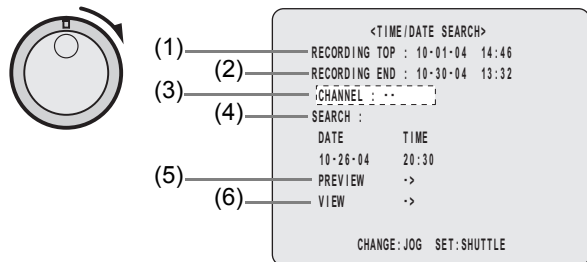

- (1) **RECORDING TOP:**
Indicates the date/time of the earliest video recording.
- (2) **RECORDING END:**
Indicates the date/time of the most-recent video recording.
- (3) **CHANNEL:**
Used to enter the channel (or camera number) for playback.
- (4) **SEARCH:**
Used to enter the date/time of the recording to be played.
- (5) **PREVIEW:**
Select this option and turn the shuttle dial clockwise to display the preview screen.
- (6) **VIEW:**
Select this option and turn the shuttle dial clockwise to play the recording.

Example: To search for a recording from camera 5 from 8:30 pm on October 26, 2004

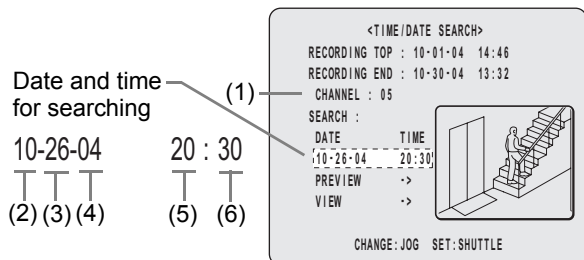

Turn the jog dial to select "CHANNEL".

- (1) Turn the shuttle dial clockwise, turn the jog dial to select "05", and then turn the shuttle dial clockwise once again.
- (2) Turn the shuttle dial clockwise, and then turn the jog dial to change to "10" (month).
- (3) Turn the shuttle dial clockwise, and then turn the jog dial to change to "26" (day).
- (4) Turn the shuttle dial clockwise, and then turn the jog dial to select "04" (year).
- (5) Turn the shuttle dial clockwise, and then turn the jog dial to select "20" (hour).
- (6) Turn the shuttle dial clockwise, turn the jog dial to change to "30" (minutes), and then turn the shuttle dial clockwise once again.

The cursor moves to "PREVIEW".

4 Turn the shuttle dial clockwise.

After searching, the recording for the date and time settings is displayed in the preview screen.

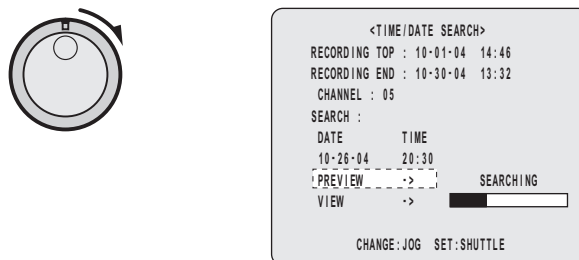

- **If no recording exists for the specified time**
The closest recording to the specified time is displayed.
- **To leave search mode**
Press the [SEARCH] button. The display returns to the normal screen.

5 Turn the jog dial clockwise to select "VIEW", and then turn the shuttle dial clockwise.

The selected recording is played back on the full screen.



NOTE

- The retrieved video can be displayed on the full screen without displaying the preview screen by entering the date and time, and by then selecting "VIEW".
- You can use the front-panel buttons, the shuttle dial, and the jog dial to perform operations such as pause and fast-forward.
- If "CHANNEL" is set to "--" and playback is started, this will take place on the multi screen.

Archive area search

Use the following procedure to playback video that has been stored in the archive area.

- 1 Press the [SEARCH] button while the digital video recorder is recording or stopped.

The SEARCH indicator lights up and the <SEARCH> screen is displayed.



- 2 Turn the jog dial to select "ARCHIVE AREA SEARCH".



- 3 Turn the shuttle dial clockwise.

The <ARCHIVE AREA SEARCH> screen is displayed. This screen lists the eight most-recent recordings in the order in which archiving was performed.

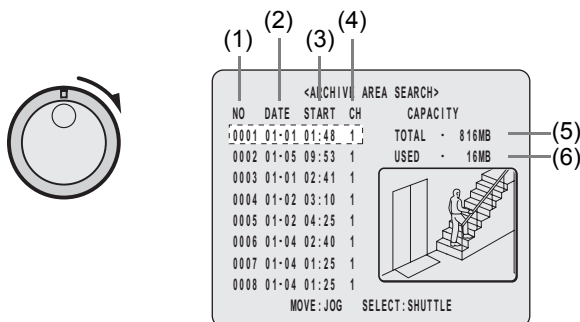

- (1) NO: Indicates the archive number.
- (2) DATE: Indicates the date of recording.
- (3) START: Indicates the start time for the recording.
- (4) CH: Indicates the channel (or camera number) for the recording.
- (5) TOTAL: Indicates the total capacity of the archive area.
- (6) USED: Indicates the amount of the archive area that has been used.

- 4 Turn the jog dial to select the video for playback.

The selected image is displayed on the preview screen.

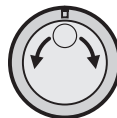

- To display the next or previous recording
Turn the jog dial clockwise or counter-clockwise accordingly.

NOTE

- Up to eight recordings can be displayed in the <ARCHIVE AREA SEARCH> screen.
- To leave search mode
Press the [SEARCH] button. SEARCH indicator turns off.

- 5 Turn the shuttle dial clockwise.

The selected recording is played back on the full screen.

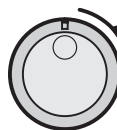

Motion detection search

By setting the motion sensor for recordings from the normal recording area (i.e., normal recordings and timer recordings) or alarm recording area, variations from these recordings as a result of the presence of an intruder or the like can be detected, and the corresponding video can be played back.

NOTE

- When a camera number (or channel) is specified, searching will only be carried out for that camera.

- 1 Press the [SEARCH] button while the digital video recorder is recording or stopped.

SEARCH indicator lights up and the <SEARCH> screen is displayed.



2 Turn the jog dial to select “MOTION DETECTION SEARCH”, and then turn the shuttle dial clockwise.

The <MOTION DETECTION SEARCH> screen is displayed.

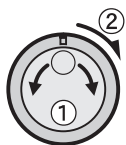

3 Turn the jog dial to select “SEARCH FROM”, and then turn the shuttle dial clockwise.

The ALARM indicator starts to flash.

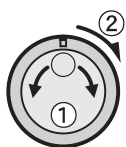

4 Turn the jog dial to select a search area, and then turn the shuttle dial clockwise.

Example: ALARM

The cursor moves to “CHANNEL”.

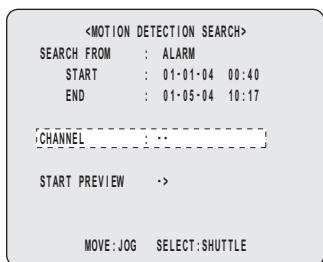
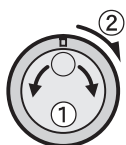

[Settings] (◆ indicates default setting)

Setting	Description
◆ALARM	Searching will only be performed for recordings in the alarm recording area.
NORMAL	Searching will only be performed for recordings in the normal recording area.
ALARM & NORMAL	Searching will be performed for recordings in the alarm recording area and normal recording area.

5 Turn the shuttle dial clockwise, and then turn the jog dial to select a camera number.

Example: 4

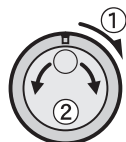

6 Turn the shuttle dial clockwise.

The cursor moves to “START PREVIEW”.

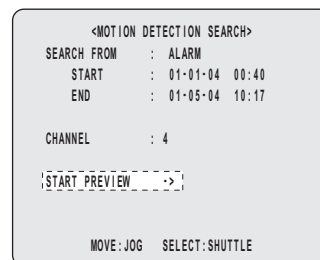
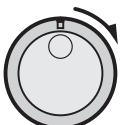

7 Turn the shuttle dial clockwise.

The screen changes and the preview screen for Camera No. 4 appears.

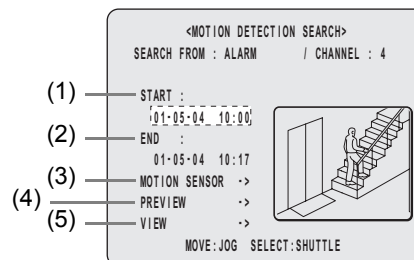
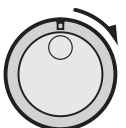

- (1) **START:**
Indicates the date and time of recording of the first image in the selected recording area(s).
- (2) **END:**
Indicates the date and time of recording of the final image in the selected recording area(s).
- (3) **MOTION SENSOR:**
Indicates the motion sensor setting.
- (4) **PREVIEW:**
Displays the selected start image.
- (5) **VIEW:**
Plays the selected recording on the full screen.

Set the motion sensor to use for searching

1 Turn the shuttle dial clockwise while video is being displayed on the preview screen.

- (1) Turn the jog dial to set the start date and time for motion sensing (i.e., 10 AM on the same day), and then turn the shuttle dial clockwise. The recording for the selected time is displayed in the preview screen. The cursor moves to the "END" date and time.

Set the start date and time.

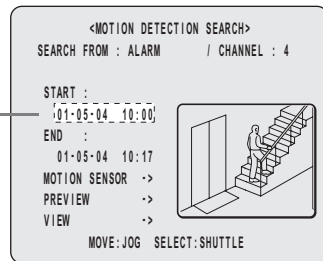

- (2) Turn the shuttle dial clockwise.
 (3) Turn the jog dial to set the end date and time for motion sensing (i.e., 8 PM on the same day), and then turn the shuttle dial clockwise. The cursor moves to "MOTION SENSOR".

Set the end date and time.

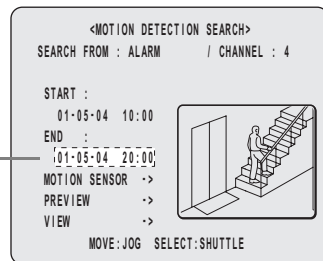

2 Turn the shuttle dial clockwise.

The motion sensor setting screen is displayed. Use the following procedure to set motion sensors at locations where movement is to be detected and viewed.

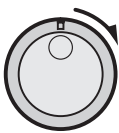

- (1) Turn the jog dial clockwise or counter-clockwise to move the cursor to the position where a sensor is to be set.



- (2) Turn the shuttle dial clockwise to set a motion sensor.
 ■ : ON, □ : OFF

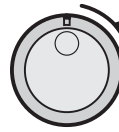

- (3) Use the jog dial in the same way to set sensors at other locations.

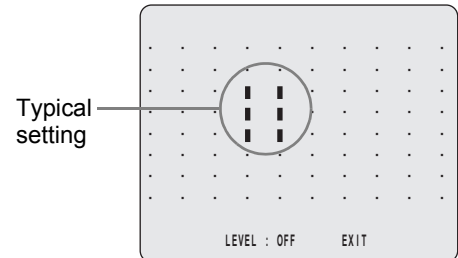

NOTE

- All sensors on the same line as the cursor can be turned on simultaneously by pressing the [MENU RESET] button.

3 Turn the jog dial to move the cursor to "LEVEL", and then turn the shuttle dial clockwise.

"OFF" flashes.



4 Turn the jog dial to select "OFF" or a sensitivity level between "1" and "10", and then turn the shuttle dial clockwise.

After setting the sensitivity level, the cursor moves to "EXIT".



[Settings] (◆ indicates default setting)

Setting	Description
◆ OFF	Motion sensing is not carried out.
1 to 10	Motion sensing is carried out. Lower values correspond to higher sensitivities.

5 Turn the shuttle dial clockwise.

The display returns to the <MOTION DETECTION SEARCH> screen.



6 Turn the jog dial to select “PREVIEW”.

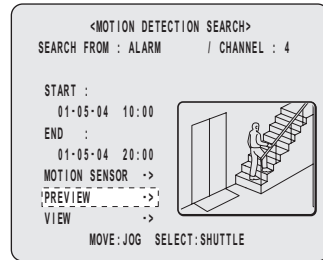

7 Turn the shuttle dial clockwise.

Each time the shuttle dial is turned clockwise, a different motion sensor screen will be displayed on the preview screen.



■ If “NOT FOUND” is displayed

Carry out motion sensor setting again.

Viewing video detected by the motion sensor on a full screen

8 Turn the jog dial to select “VIEW”, and then turn the shuttle dial clockwise.

Normal playback will be started for the specified recording.



! CAUTION

- By specifying a camera number (or channel) and performing MOTION DETECTION SEARCH, playback can be carried out for only the specified camera number.
In such a case, the title information, date information, and/or time information may partially disappear.
- To playback a recording from a different camera, stop the current playback and then repeat the setting process from the beginning.

Use the procedures described below to copy important video stored in the normal recording area or the alarm recording area to the digital video recorder's archive area, a CompactFlash card, a Microdrive or CD-R/RW.

Copying video to the hard disk's archive area (→P.39)

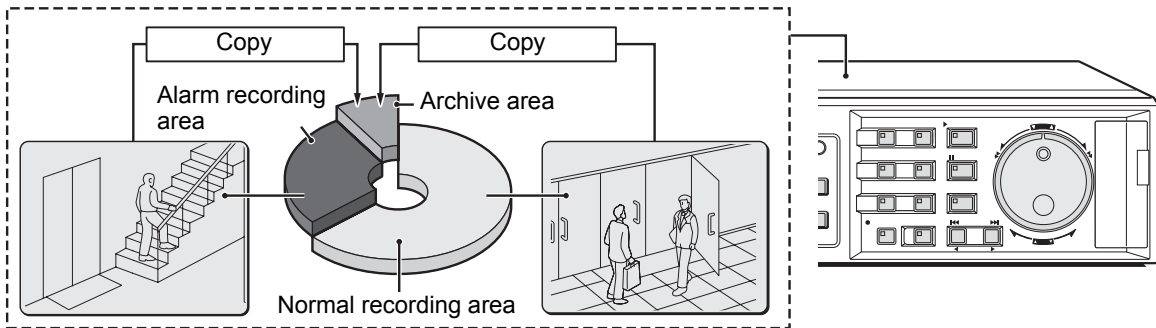

Copying video to a CompactFlash card or Microdrive (→P.41)

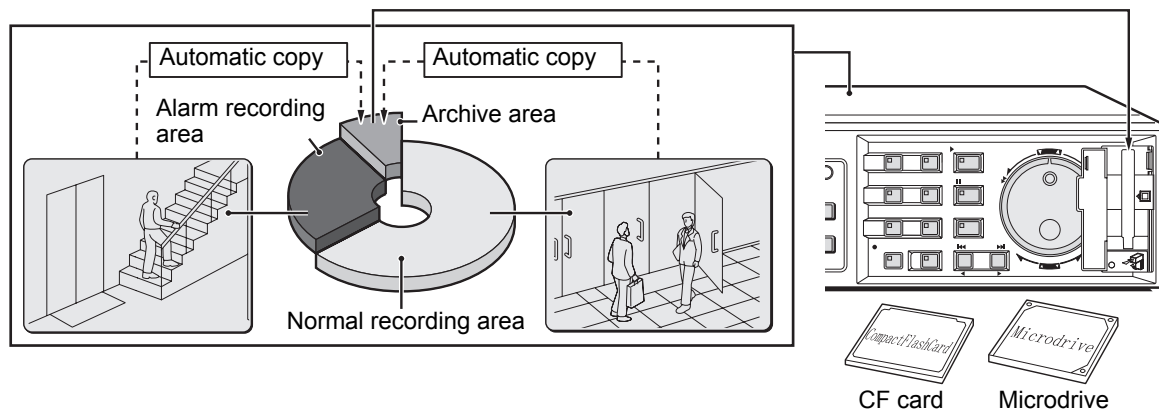

Copying video to a CD-R/RW (→P.45)

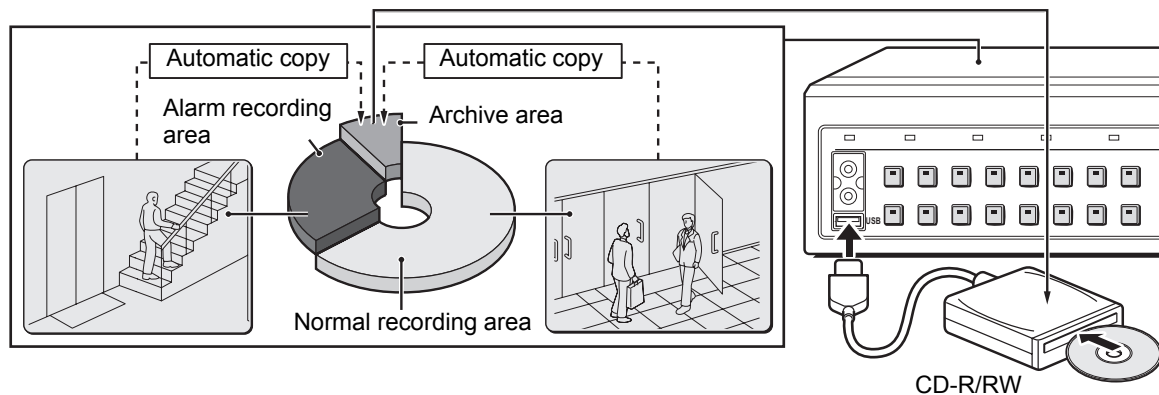

NOTE

- Copied data is stored as a continuous recording.
- When video is being downloaded from the normal recording area or alarm recording area to a CompactFlash card, a Microdrive or CD-R/RW, it is temporarily stored in the archive area before being copied from there to each media. Consequently, the amount of free space in the archive area is the maximum amount that can be copied. Note, however, that this video will not be retained in the archive area.

- If archive area becomes full, copy important video to a CompactFlash card, a Microdrive or CD-R/RW. (→P.41) Following this, delete data from the archive area using "AREA FULL RESET" from the "ARCHIVE AREA" in "2.RECORDING AREA SET" on the <RECORD SET> sub-menu. (→P.67)

Copying video to the hard disk's archive area

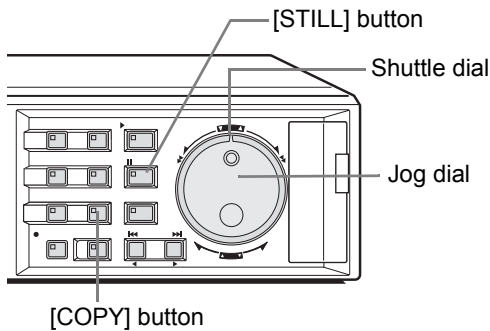

- 1 Play video from the normal recording area or the alarm recording area.
- 2 Press the [STILL] button when the frame to be copied is displayed.



! CAUTION

- Images from all cameras cannot be copied simultaneously. Use the appropriate [CAMERA SELECT] button to select the camera whose video is to be copied.

Example: Copying a specified 10-second portion of video

- 3 Press the [COPY] button.

The COPY indicator lights up and the <COPY> screen is displayed.

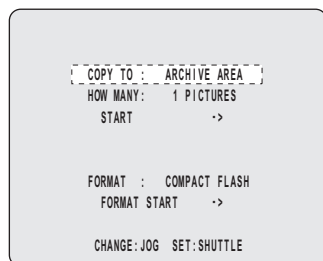

- 4 Turn the jog dial to select "COPY TO", and then turn the shuttle dial clockwise.

"ARCHIVE AREA" starts to flash.

[Settings] (◆ indicates default setting)

Setting	Description
◆ ARCHIVE AREA	Video will be copied to the archive area. (→P.39)
COMPACT FLASH	Video will be copied to a CompactFlash card. (→P.41)
CF->PRINT	Copy to a CompactFlash card and print directly from a printer. (→P.43)
CD-R/RW	Copy to a CD-R/RW. This is only displayed when a recordable CD-R/RW drive is connected to the digital video recorder. (→P.45)

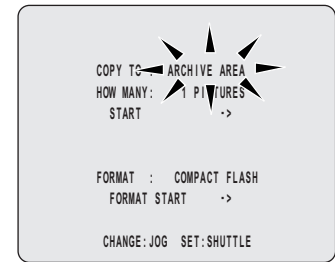

- 5 Turn the jog dial to select "ARCHIVE AREA", and then turn the shuttle dial clockwise.

The cursor moves to "HOW MANY".

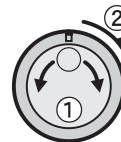

- 6 Turn the shuttle dial clockwise, and then turn the jog dial to set "HOW MANY" to "10".

Any value between 1 and 60 can be set.

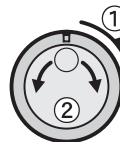

7 Turn the shuttle dial clockwise.

“PICTURES” flashes.

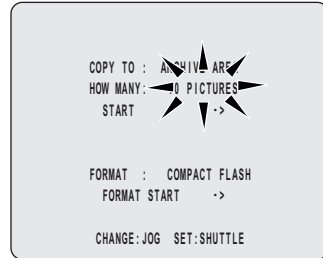

8 Turn the jog dial to select “SECONDS”.



[Settings] (◆ indicates default setting)

Setting	Description
◆ PICTURES	The specified number of images after the specified location will be copied.
SECONDS	The specified duration in seconds after the specified location will be copied.
MINUTES	The specified duration in minutes after the specified location will be copied.

9 Turn the shuttle dial clockwise.

The cursor moves to “START”.

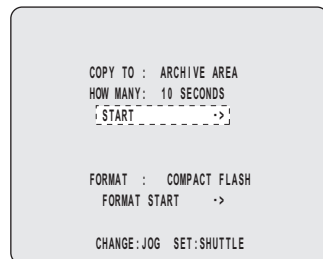
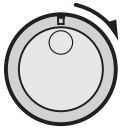

10 Turn the shuttle dial clockwise.

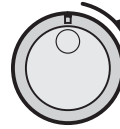

- (1) Copying to the archive area commences. The message “COPY TO ARCHIVE AREA !” is displayed on-screen during the copy procedure.



- (2) When this procedure has been completed, “COPY FINISHED !” is displayed.



■ To cancel a copy operation

Press the [COPY] button to cancel the current copy.

Copying video to a CompactFlash card or Microdrive

Use the following procedure to copy video either to a Microdrive and to a CompactFlash card (Supported up to 2 GB).

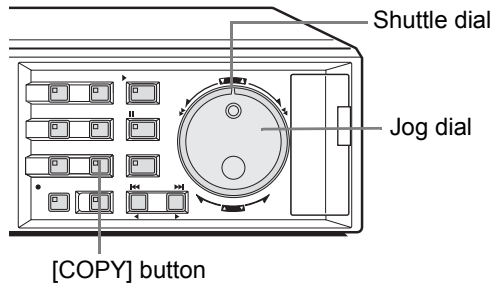

1 Insert a CompactFlash card.

Insertion method

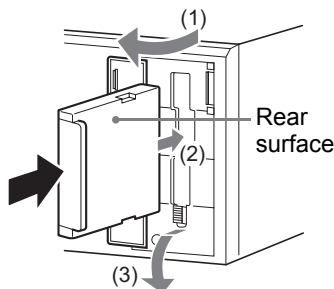

- (1) Open the cover.
- (2) Ensuring that it is correctly oriented, insert the CompactFlash card into the CompactFlash card slot.
- (3) Fold down the lever.

Removal method

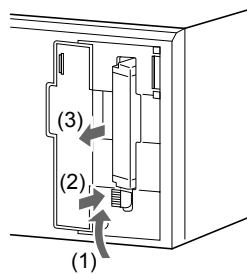

- (1) Raise the lever.
- (2) Push in the lever.
- (3) Remove the CompactFlash card.

Example: Copying a specified 10-second portion of video

2 Pause playback on the image to be copied, and then press the [COPY] button.

The <COPY> screen is displayed.

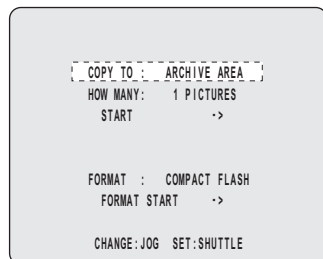

3 Turn the jog dial to select "COPY TO", and then turn the shuttle dial clockwise.

"ARCHIVE AREA" flashes.

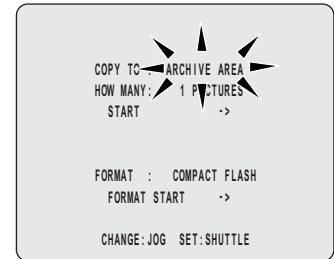

4 Turn the jog dial to select "COMPACT FLASH", and then turn the shuttle dial clockwise.

The cursor moves to "HOW MANY".

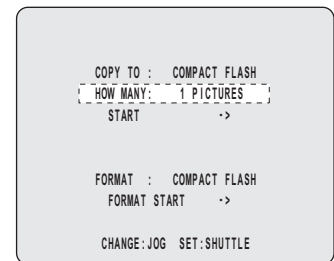

5 Turn the shuttle dial clockwise, and then turn the jog dial to set "HOW MANY".

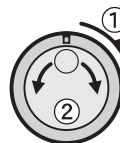

6 Turn the shuttle dial clockwise.

"PICTURES" flashes.



7 Turn the jog dial to select "SECONDS".

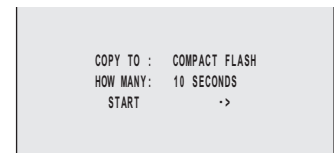
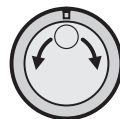

[Settings] (◆ indicates default setting)

Setting	Description
◆ PICTURES	The specified number of images after the specified location will be copied.
SECONDS	The specified duration in seconds after the specified location will be copied.
MINUTES	The specified duration in minutes after the specified location will be copied.

NOTE

- Up to 40,000 images can be copied in a single operation. When specifying the number of images using "MINUTES", copying will end at the point at which 40,000 images are copied.
- Alarm recordings can only be copied one event at a time.

8 Turn the shuttle dial clockwise.

The cursor moves to "START".

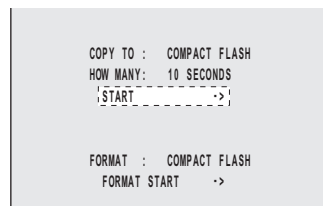
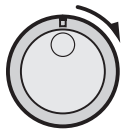

9 Turn the shuttle dial clockwise.



- (1) Copying to the CompactFlash card starts. The message "COPY TO COMPACT FLASH !" is displayed on-screen at this time.



- (2) When this has been completed, "COPY FINISHED !" is displayed.



■ To cancel a copy operation

Press the [COPY] button to cancel the current copy.

! CAUTION

- If the CompactFlash card becomes full during the copying process, the message "COMPACT FLASH FULL!" will be displayed and copying will end. Press any button to return to the normal screen. The copy procedure should now be repeated using a new CompactFlash card.
- JPEG images
JPEG files contain field images, and for this reason, they will be 50% compressed in the vertical direction when viewed using commercially-available image processing software. These files should, therefore, be opened using the INDEX.HTM file.
- Images copied to a CompactFlash card
Since images copied to a CompactFlash card contain embedded coding for the detection of manipulation, these codes can be detected using a suitable software application. For more information, contact the dealer from whom you purchased this digital video recorder.
- Use a FAT16 CompactFlash card. The digital video recorder will not recognize FAT32 CompactFlash cards. Format cards with the digital video recorder before use.

NOTE

- When images are copied directly from the normal recording area or the alarm recording area to a CompactFlash card, these images will be temporarily copied to the archive area. Consequently, the amount of free space in the archive area is the maximum amount that can be copied. Note, however, that this data will be automatically deleted when copying has been completed.
- When copying images to a CompactFlash card, approximately 15 seconds will be required for 1 MB.

4 Turn the jog dial to select “CF -> PRINT”, and then turn the shuttle dial clockwise.

The cursor moves to “HOW MANY”.

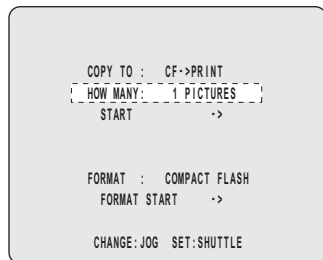

5 Turn the shuttle dial clockwise, and then turn the jog dial to set “HOW MANY”.

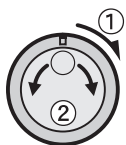

6 Turn the shuttle dial clockwise and turn the jog dial to set units.

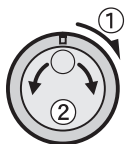

[Settings] (◆ indicates default setting)

Setting	Description
◆ PICTURES	The specified number of images after the specified location will be copied.
SECONDS	The specified duration in seconds after the specified location will be copied.
MINUTES	The specified duration in minutes after the specified location will be copied.

7 Turn the shuttle dial clockwise.

The cursor moves to “START”.

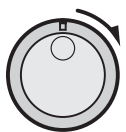

8 Turn the shuttle dial clockwise.

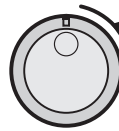

CompactFlash card

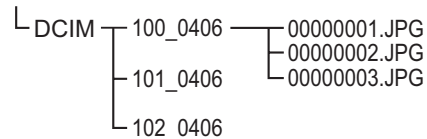

- (1) A folder with the name “DCIM” is created inside the root directory.
- (2) Within “DCIM,” a folder with the date on which images were copied to is created.

! CAUTION

- Use the “DVP-P1” Sanyo Digital Photo Printer. If another printer is used, Sanyo cannot be responsible for failures in performance or operation.

NOTE

- If the location of the date needs to be moved when printing, change operation display area at copying. (→P.16)
When date is hidden, it is not printed.
- When “CF->PRINT” is selected, copying may take twice as long as “COMPACT FLASH”, with approximately 30 seconds required for each megabyte of data.

! CAUTION

- Copies will be limited to 999 when “CF->PRINT” is selected.
Example: Copying ends at 999 even when set to 10 minutes.
- Images copied with “CF->PRINT” settings cannot be played on the DVR Viewer.

■ To cancel a copy operation

Press the [COPY] button to cancel the current copy.

Copying video to CD-R/RW

- 1** Connect a recordable CD-R/RW drive and insert a disk.

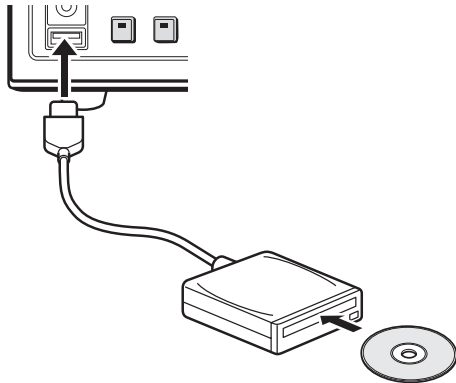

! CAUTION

- The digital video recorder has one USB terminal on the front and one on the back, but they cannot be used simultaneously. Connect recordable drive to either terminal. If both sides have devices connected, the front terminal is prioritized.
- Use the recommended CD-R/RW drive.

- 2** Pause playback on the image to be copied, and then press the [COPY] button.

The <COPY> screen is displayed.

COPY



- 3** Turn the jog dial to select “COPY TO”, and then turn the shuttle dial clockwise.

“ARCHIVE AREA” flashes.

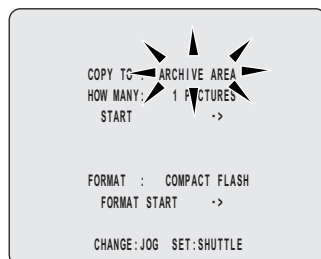
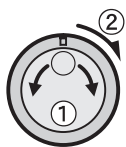

- 4** Turn the jog dial to select “CD-R/RW”, and then turn the shuttle dial clockwise.

The cursor moves to “HOW MANY”.



- 5** Turn the shuttle dial clockwise, and then turn the jog dial to set “HOW MANY”.

Any value between 1 and 60 can be set.

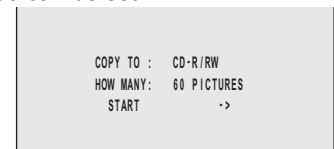

- 6** Turn the shuttle dial clockwise.

“PICTURES” flashes.

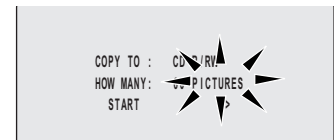

- 7** Turn the jog dial to select the unit.

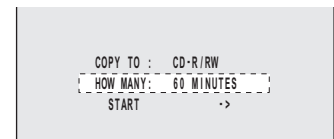
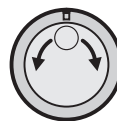

[Settings] (◆ indicates default setting)

Setting	Description
◆ PICTURES	The specified number of images after the specified location will be copied.
SECONDS	The specified duration in seconds after the specified location will be copied.
MINUTES	The specified duration in minutes after the specified location will be copied.

! CAUTION

- Up to 40,000 images can be copied in a single operation. When specifying the number of images using “MINUTES”, copying will end at the point at which 40,000 images are copied.
- Alarm recordings can only be copied one event at a time.

8 Turn the shuttle dial clockwise.

The cursor moves to “START”.

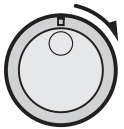
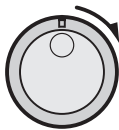
**9 Turn the shuttle dial clockwise.**

- (1) Copying to the CD-R/RW starts. The message “COPY TO CD-R/RW !” is displayed on-screen at this time.



- (2) When this has been completed, “COPY FINISHED !” is displayed.

**■ To cancel a copy operation**

Copying to the CD-R/RW cannot be cancelled once started.

! CAUTION

- When copying to CD-R/RW drive and “NO CD-R/RW !” appears, check that the disc is properly set. If an error message appears when set properly, insert a new disc and try again.

Viewing images copied to a CD-R/RW on a PC

Use the following procedure to view images copied to a CD-R/RW on a PC.

When images are copied to a CD-R/RW the following folders are created and images are saved within them.

SANYOCDR (disc name)

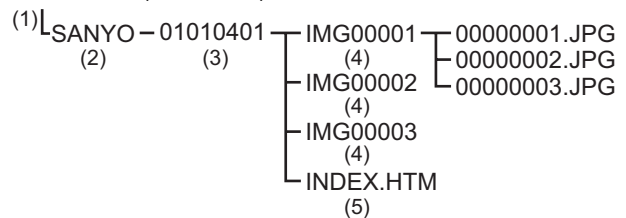

- (1) CD-R/RW disc is named “SANYOCDR.”
- (2) A folder with the name “SANYO” is created inside “SANYOCDR.”
- (3) Within “SANYO,” a folder with the date on which images were copied to is created.
- (4) Under the date folder, folders with titles starting from “IMG00001” are created. Up to 200 images can be saved on each folder.
- (5) To view images on your PC, open the file “INDEX.HTM” found in each date folder using a browser (i.e., Internet Explorer 5.0 or later). You will then be able to view the JPEG images individually or in slide show format, etc.

Playback with the DVR Viewer is also possible.

Formatting a CompactFlash card and CD-RW

Format CompactFlash cards, microdrives, and CD-RW by selecting media with “FORMAT” and activating “FORMAT START.”

**! CAUTION**

- CompactFlash capacity is up to 2GB.
- The USB terminal is for the use of the recommended Sanyo CD-R/RW drive (sold separately). Non-recommended peripherals cannot be connected.
- For recommended recordable drives, check the Sanyo homepage or ask at your local Sanyo dealer.

Sanyo website URL:

<http://www.sanyosecurity.com>

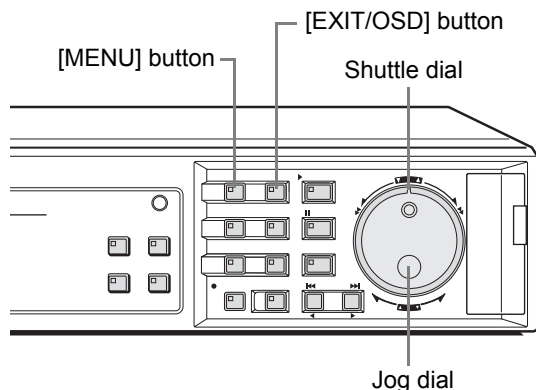

This section describes the menu configuration and the menu items to be selected for each operation.

Basic menu operations

1 Press the [MENU] button.

The MENU indicator lights up and the <MAIN MENU> is displayed.



Moving from the <MAIN MENU> to a sub-menu or setting screen

2 Turn the jog dial to select a menu.

Example: 2. RECORD SET

When you move the cursor, the selected item is displayed in reverse.



Cursor position

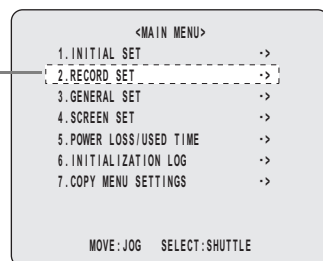

3 Turn the shuttle dial clockwise.

The sub-menus appear.

The cursor is positioned on the first setting item.



4 Turn the jog dial to select a sub-menu, and then turn the shuttle dial clockwise.

The corresponding setting screen is displayed, and the cursor is positioned on the first item.

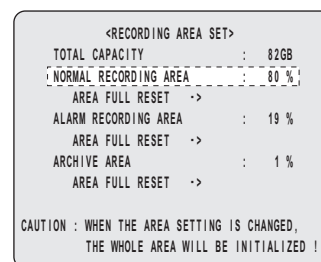
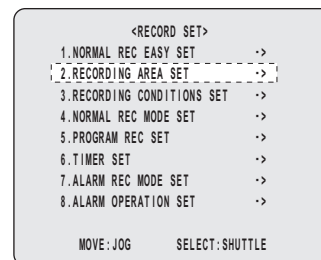

■ To return to the previous menu

Turn the shuttle dial counter-clockwise.

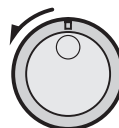

5 Press the [EXIT/OSD] button.

The setting procedure is ended and the display returns to the normal screen.



NOTE

- Menu can be opened even during the recording process.
- Menu settings cannot be changed during the recording process. Accordingly, recording will have to be stopped in order to allow changes to be made.

Movement and confirmation in sub-menus and setting screens

The jog dial and shuttle dial are used for movement and confirmation in sub-menus and setting screens.

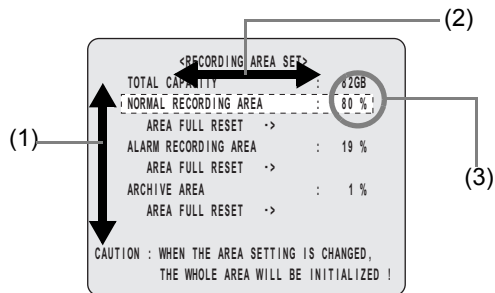

(1)	To move the cursor up or down	Turn the jog dial.	
(2)	To move the cursor right or to confirm an item	Turn the shuttle dial clockwise.	
(3)	To change a setting value	Turn the jog dial.	

Entering numbers with the numeric keys

Use the [CAMERA SELECT] buttons on the front panel to enter numbers and channels (camera numbers). Numbers can be entered when “K” is displayed at the top-right of the menu screen. (→P.121)

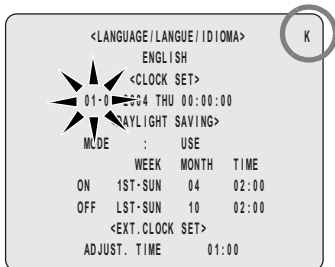

Numbers to be entered	Button guide
1 to 9	No. 1 to No. 9 [CAMERA SELECT] buttons
0	[QUAD] button

Restoring menu setting items to their default values

Use the following procedure to restore only those items in the displayed setting screen to their default values.

- 1 Open the screen containing the items to be returned to default settings.
- 2 Press the [MENU RESET] button.

The displayed settings are restored to their default values.

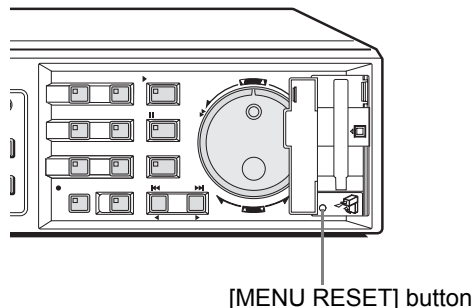

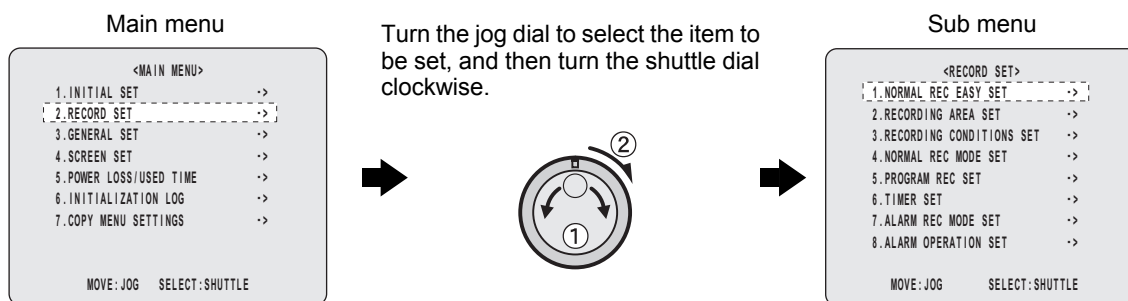

Sub-menu configuration

The following table indicates the sub-menus or setting screens displayed by selecting items from the <MAIN MENU>. The [MENU] button can be used in any sub-menu to scroll through each of the sub-menus in sequence.

	Sub menu	Setting item	Settings or display content
1	<INITIAL SET> This sub-menu is used to make initial settings. 	(1) LANGUAGE/CLOCK SET (→P.51)	Sets the language displayed on the monitor. Set the date and time displayed on the normal screen and daylight saving. Aligns the time of all digital video recorders in situations where multiple recorders are connected.
		(2) CAMERA DETECT (→P.54)	Automatically detects cameras that have been connected.
		(3) TITLE SET (→P.55)	Sets a unique title for each camera so that these can be displayed on-screen.
		(4) HOLIDAY SET (→P.56)	Sets specific dates as holidays to have the operation for Sunday used on those days also.
		(5) TIME PERIOD SET (→P.57)	Sets a time period for automatic camera selection and the switching of masking and motion-sensor operations.
2	<RECORD SET> This sub-menu is used to set recording and alarms. 	(1) NORMAL REC EASY SET (→P.60)	Makes basic settings based on a number of days or recording rate.
		(2) RECORDING AREA SET (→P.64)	Displays the total capacity of the hard disk. Sets the normal recording area, the alarm recording area, the archive area.
		(3) RECORDING CONDITIONS SET (→P.67)	Sets whether overwriting is to be performed (by deleting old video) or recording is to be stopped when any of the hard disk's recording areas become full. Also sets series recording and auto delete.
		(4) NORMAL REC MODE SET (→P.71)	Sets the recording quality, audio recording, the recording rate, and program recording.
		(5) PROGRAM REC SET (→P.73)	Sets program recording for cameras and the program recording rate.
		(6) TIMER SET (→P.74)	Makes timer settings so that operations can be started at a specified time or on a specified day.
		(7) ALARM REC MODE SET (→P.77)	Sets alarm recording, pre-alarm recording, and motion sensors.
		(8) ALARM OPERATION SET (→P.84)	Makes settings for alarms and displays used to detect intruders.
3	<GENERAL SET> This sub-menu is used to make settings for monitor display and the system. 	(1) DISPLAY SET (→P.86)	Sets display switching for the operation display area. Enables "VIDEO LOSS" to be displayed when the camera video is interrupted.
		(2) BUZZER SET (→P.88)	Turns the buzzer on or off.
		(3) SECURITY LOCK SET (→P.89)	Sets passwords that restrict use of the digital video recorder to administrators and designated users, thus preventing unauthorized operation.
		(4) HDD SET (→P.92)	Allows confirmation of hard disk capacity and performs initialization. Makes the required settings for mirroring.
		(5) NETWORK SET (→P.93)	Makes settings to allow remote setting of the digital video recorder's menu items and remote monitoring of video from a PC via a network (LAN).
		(6) RS-485 SET (→P.96)	Makes settings when using RS-485.
		(7) CAMERA CONTROL SET (→P.97)	Makes settings to allow control of the cameras from the digital video recorder.

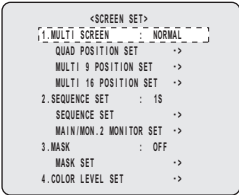
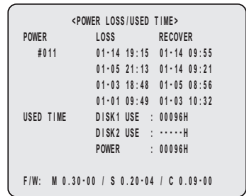
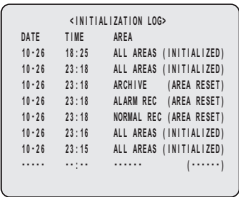
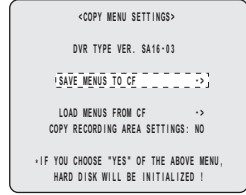
	Sub menu	Setting item	Settings or display content
4	<p><SCREEN SET> This sub-menu is used to make screen settings for monitoring.</p> 	<p>(1) MULTI SCREEN (→P.100)</p> <p>(2) SEQUENCE SET (→P.102)</p> <p>(3) MASK (→P.104)</p> <p>(4) COLOR LEVEL (→P.105)</p>	<p>Specifies the positions of video from different cameras on the quad, multi 9 and 16 screens.</p> <p>Sets the switching interval for automatic camera selection. Selects the cameras to be displayed on both the main monitor and monitor 2 as a result of automatic selection.</p> <p>Sets video from individual cameras to be masked by a gray pattern when it is not to be monitored. Turns each channel on and off, and sets time synchronization.</p> <p>Adjusts the color of video displayed on monitors.</p>
5	<p><POWER LOSS/USED TIME> This sub-menu is used to confirm the date and time of power losses and the amount of hard disk usage.</p> 	(→P.107)	Provides a display of the date and time of power losses and the amount of hard disk usage.
6	<p><INITIALIZATION LOG> This sub-menu is used to display a hard-disk initialization and area-reset log.</p> 	(→P.108)	Displays a record of hard-disk initialization and each area resetting.
7	<p><COPY MENU SETTINGS> This sub-menu is used to store or load menu settings</p> 	(→P.109)	Saves and loads menu settings.

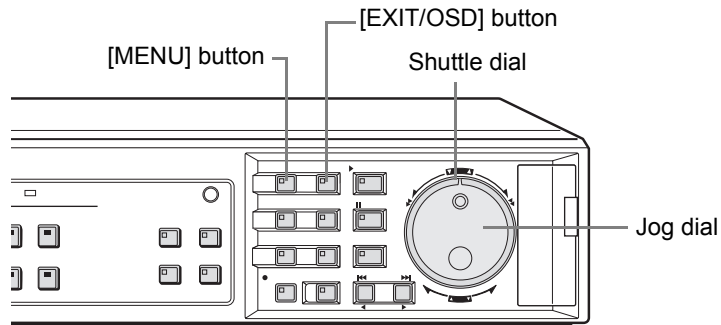

Initial settings

The <INITIAL SET> is used to make the following setting.



Setting	Description	Ref.
5	<p><TIME PERIOD SET> Uses a pair of time periods to set a time band for operation switching and other functions.</p>	P.57

Setting the time

Setting of the date and time displayed on the normal screen. See P.17 for more details.

Setting the daylight saving

1 Press the [MENU] button.

The MENU indicator lights up and the <MAIN MENU> is displayed.



2 Turn the jog dial to select "1. INITIAL SET", and then turn the shuttle dial clockwise.

The <INITIAL SET> screen is displayed.

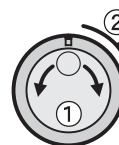

Setting	Description	Ref.
1	<p><LANGUAGE/CLOCK SET> Sets the language displayed on the monitor. Set the date and time displayed on the normal screen and daylight saving. Aligns the time of all digital video recorders in situations where multiple recorders are connected.</p>	P.16 P.51
2	<p><CAMERA DETECT> Automatically detects cameras that have been connected.</p>	P.54
3	<p><TITLE SET> Sets a unique title for each camera so that these can be displayed on-screen.</p>	P.55
4	<p><HOLIDAY SET> Sets specific dates as holidays to have the operation for Sunday used on those days also.</p>	P.56

3 Turn the jog dial to select "1. LANGUAGE/CLOCK SET", and then turn the shuttle dial clockwise.

The <LANGUAGE/LANGUE/IDIOMA> screen is displayed.



4 Turn the jog dial to select "MODE" under <DAYLIGHT SAVING>.



5 Turn the shuttle dial clockwise.

"USE" flashes.



6 Turn the jog dial to change the settings.

[Settings] (◆ indicates setting)

Setting	Description
◆ USE	Time is automatically adjusted to daylight saving.
NO USE	Time is not automatically adjusted to daylight saving.

7 Turn the shuttle dial clockwise.

The cursor moves to the date/time at which to switch from standard time to daylight saving.



When "USE" is selected for <DAYLIGHT SAVING>

You can set the date/time at which the time is switched from standard time to daylight saving, and the date/time at which the time is switched back again.

The example below is the default value.

Example:

After the clock display reaches April 4, 2004, 01:59, the next clock display is 03:00, putting the clock an hour ahead.

After the clock display reaches October 31, 2004, 01:59, the next clock display is 01:00, putting the clock an hour behind (back to standard time).

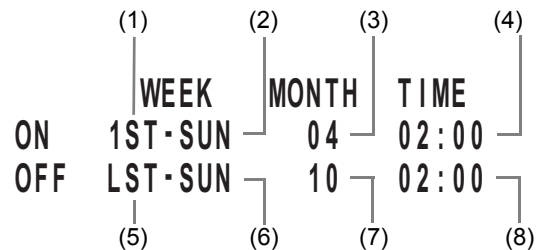

- (1) Sets the week for switching to daylight saving.
- (2) Sets the day of the week.
- (3) Sets the month.
- (4) Sets the time.
- (5) Sets the week for ending daylight saving.
- (6) Sets the day of the week.
- (7) Sets the month.
- (8) Sets the time.

8 Turn the shuttle dial clockwise.

"1ST" flashes.

9 Turn the jog dial to select the desired week, and then turn the shuttle dial clockwise.

The cursor moves to the day of the week.

10 Turn the jog dial to select the desired day of the week, and then turn the shuttle dial clockwise.

The cursor moves to the month.

11 Select month with the jog dial or numeric keys and turn the shuttle dial clockwise.

The cursor moves to the time.

12 Select time with the jog dial or numeric keys and turn the shuttle dial clockwise.

The cursor moves to the minutes portion of the time. Set the desired minutes in the same manner.

Use the same procedure when setting the time at which daylight saving is to end. The <DAYLIGHT SAVING> settings are now finished.

External clock setting

Alignment of the time of all digital video recorders in situations where multiple recorders are connected.
(Default setting: 01:00)

At the set time, all connected recorders will be aligned to the same time to a precision of seconds.

1 Connect the CLOCK SET OUT terminal on the rear of the first digital video recorder to the CLOCK SET IN of the second recorder.

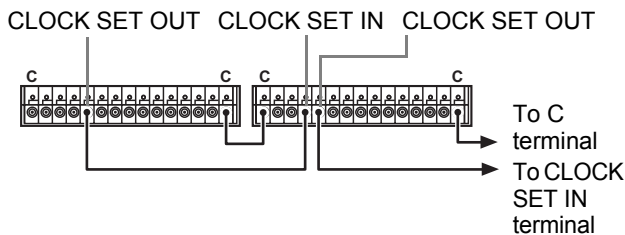

2 Press the [MENU] button.

The MENU indicator lights up and the <MAIN MENU> is displayed.



3 Turn the jog dial to select "1. INITIAL SET", and then turn the shuttle dial clockwise.

The <INITIAL SET> screen is displayed.

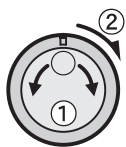

4 Turn the jog dial to select "1. LANGUAGE/CLOCK SET", and then turn the shuttle dial clockwise.

The <LANGUAGE/LANGUE/IDIOMA> screen is displayed.



5 Turn the jog dial and move the cursor to "ADJUST. TIME".



6 Turn the shuttle dial clockwise.

"01" flashes.

7 Set time with the jog dial or numeric keys and turn the shuttle dial clockwise.

Example: 05:00



8 Press the [EXIT/OSD] button.

The setting procedure for the first digital video recorder is ended and the display returns to the normal screen.



9 Use the same procedure to set the time for all subsequent recorders.

When you have finished making the settings, the display returns to the normal screen.

The default setting value is "01:00".

! CAUTION

- Set the time to the same time of first digital video recorder.

NOTE

- Only an hour value can be set using "ADJUST. TIME". It is not possible to set a value for minutes and seconds.

Detecting connected cameras

Use the following procedure to automatically detect cameras that have been connected. An "OFF" setting should be made for cameras that have not been connected.

1 Press the [MENU] button.

The MENU indicator lights up and the <MAIN MENU> is displayed.



2 Turn the jog dial to select "1. INITIAL SET", and then turn the shuttle dial clockwise.

The <INITIAL SET> screen is displayed.



3 Turn the jog dial to select "2. CAMERA DETECT", and then turn the shuttle dial clockwise.



<WARNING> screen is displayed.



4 Turn the jog dial to select "YES", and then turn the shuttle dial clockwise.

Connected cameras are automatically detected.

When detection has been completed, the display returns to the <INITIAL SET> screen.

Setting camera titles

Use the following procedure to set a unique title for each camera so that these titles can be displayed on-screen.

! CAUTION

Titles can be up to 10 characters in length per camera. The following characters can be used.

- Letters: A to Z
- Numbers: 0 to 9
- Symbols: - : . / * _ (space)

Example: Setting the title "HALL-1F" for Camera No. 3.

1 Press the [MENU] button.

The MENU indicator lights up and the <MAIN MENU> is displayed.



2 Turn the jog dial to select "1. INITIAL SET", and then turn the shuttle dial clockwise.

The <INITIAL SET> screen is displayed.



3 Turn the jog dial to select "3. TITLE SET", and then turn the shuttle dial clockwise.

The normal monitoring screen is displayed with a title setting field in the center.



4 Press the No. 3 [CAMERA SELECT] button.

The video from Camera No. 3 is displayed on-screen.

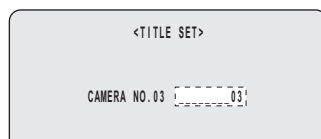

5 Turn the shuttle dial clockwise.

The first position for title setting flashes.

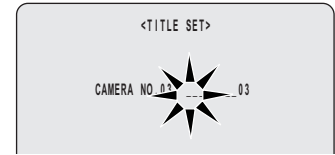

6 Turn the jog dial to select "H".

Characters change in the following sequence as the jog dial is turned.

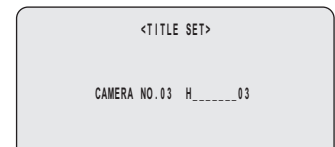
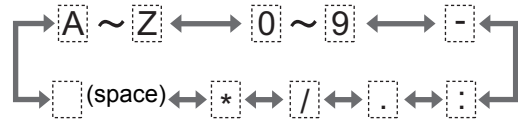

7 Turn the shuttle dial clockwise.

The character selection is confirmed and the cursor moves one position to the right.

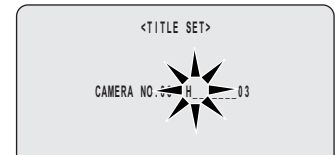

NOTE

- When changing a character, move the cursor to that character by turning the shuttle dial clockwise or counter-clockwise, and then enter the required character.

8 Repeat steps 5 and 6 to enter the remaining characters.



9 When you have finished making settings, press the [EXIT/OSD] button.

The setting procedure is ended and the display returns to the normal screen.

The default setting is "----01" (camera No.).



Setting holidays

Use the following procedure to set specific dates as holidays to have the operation for Sunday used on those days also. Dates such as national holidays and company off days should be set as holidays when you want those dates to have the same timer operation as Sundays.

[Setting conditions]

Be sure to always switch "SET" to "ON" after completing timer settings for Sunday (i.e., "SUN"). (→P.74)

Settings for Sunday

<TIMER SET>					
WEEK	START	STOP	PROGRAM	FPS	SET
SUN	08:00	18:00	OFF	15 FPS	ON
MON	OFF	15 FPS	OFF
TUE	OFF	15 FPS	OFF
WED	OFF	15 FPS	OFF
THU	OFF	15 FPS	OFF
FRI	OFF	15 FPS	OFF
SAT	OFF	15 FPS	OFF
DLY	OFF	15 FPS	OFF
EXT	OFF	15 FPS	OFF

Example: Setting November 17 as a holiday

1 Press the [MENU] button.

The MENU indicator lights up and the <MAIN MENU> is displayed.



2 Turn the jog dial to select "1. INITIAL SET", and then turn the shuttle dial clockwise.

The <INITIAL SET> screen is displayed.



<INITIAL SET>	
1. LANGUAGE/CLOCK SET	->
2. CAMERA DETECT	->
3. TITLE SET	->
4. HOLIDAY SET	->
5. TIME PERIOD SET	->

MOVE: JOG SELECT: SHUTTLE

3 Turn the jog dial to select "4. HOLIDAY SET", and then turn the shuttle dial clockwise.

The <HOLIDAY SET> screen is displayed with the cursor positioned on "1".

<HOLIDAY SET>	
1.	11.
2.	12.
3.	13.
4.	14.
5.	15.
6.	16.
7.	17.
8.	18.
9.	19.
10.	20.

4 Set the month and day for item No. "1".

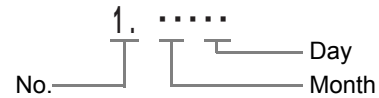

- Turn the shuttle dial clockwise to flash "--" (month).
- Set "--" to "11" with the jog dial or numeric keys.



- Turn the shuttle dial clockwise to flash "--" (day).
- Set "--" to "17" with the jog dial or numeric keys.



5 Turn the shuttle dial clockwise after setting.

The cursor moves to "2".

1. 11.17
2.

6 Use the same procedure to set other holidays.

7 Press the [EXIT/OSD] button.

The setting procedure is ended and the display returns to the normal screen.

The default setting is all "----".



! CAUTION

- If "DLY" is set using timer settings, timer recording on the above-mentioned holidays will also be carried out in accordance with daily settings. In other words, "DLY" includes Sundays and is given priority over other settings.

Time period settings

Example 1: Setting periods using TIME PERIOD A and TIME PERIOD B

● TIME PERIOD A settings

- Set T-1 to 6 AM (6:00)
- Set T-2 to 11:30 AM (11:30)
- Set T-3 to 1:30 PM (13:30)
- Set T-4 to 6 PM (18:00)

● TIME PERIOD B settings

- Set T-1 to 6 AM (6:00)
- Set T-2 to 8 AM (8:00)
- Set T-3 to 2:30 PM (14:30)
- Set T-4 to 8 PM (20:00)

NOTE

- “T-1” to “T-4” sets the start time of interval.

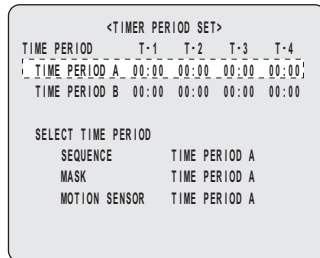

1 Press the [MENU] button.

The MENU indicator lights up and the <MAIN MENU> is displayed.



2 Turn the jog dial to select “1. INITIAL SET”, and then turn the shuttle dial clockwise.

The <INITIAL SET> screen is displayed.

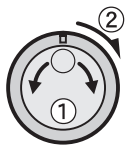

3 Turn the jog dial to select “5. TIME PERIOD SET”, and then turn the shuttle dial clockwise.

The <TIME PERIOD SET> screen is displayed.

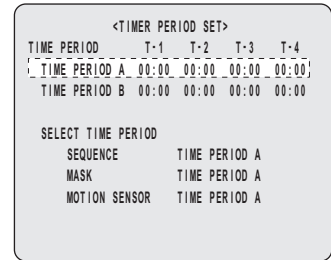

4 Turn the jog dial to select “TIME PERIOD A”, and then turn the shuttle dial clockwise.

“00:” from T-1 flashes (indicating the hour).



5 Set T-1 (indicating the hour) to “06” with the jog dial or numeric keys and turn the shuttle dial clockwise.

“:00” from T-1 flashes (indicating the minutes).

6 Set T-1 (indicating the minutes) to “00” with the jog dial or numeric keys and turn the shuttle dial clockwise.

“00:” from T-2 flashes (indicating the hour).

7 Set T-2 (indicating the hour) to “11” with the jog dial or numeric keys and turn the shuttle dial clockwise.

“:00” from T-2 flashes (indicating the minutes).

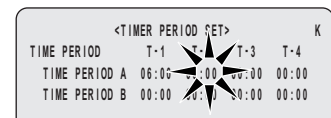

8 Set T-2 (indicating the minutes) to “30” with the jog dial or numeric keys and turn the shuttle dial clockwise.

“00:” from T-3 flashes (indicating the hour).

Repeat steps 4 through 7 to make hour and minute settings for T-3 and T-4.

- 9** In the same manner as described set the hours and minutes of T-1, T-2, T-3, and T-4 for “TIME PERIOD B” settings.

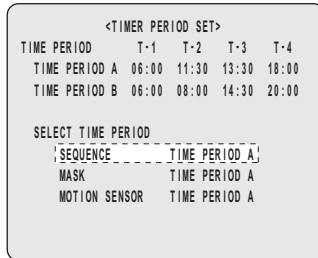

For both TIME PERIOD A and TIME PERIOD B, all settings are “00:00” by default.

! CAUTION

- Settings for T-1 through T-4 cannot be made in such a way that they extend over two days (i.e., include midnight).

Example: T-1 T-2 T-3 T-4
 06:00 12:00 18:00 02:00

In the above example, setting is not possible between T-3 and T-4 due to the change in the date.

- Any setting of “00:00” for T-2 through T-4 will be skipped. If “00:00” (midnight) must be set, this should be done using T-1.

Example: T-1 T-2 T-3 T-4
 06:00 12:00 18:00 00:00

In the above example, T-4 (00:00) is skipped and T-3 operates between 18:00 and 06:00.

- Furthermore, when T-1 through T-4 are all set to “00:00”, all but T-1 are ignored, and T-1 operates from midnight to midnight.

Time period operations settings

Example 2: Setting time period operation as follows. Automatic selection and monitor masking for “TIME PERIOD A”.

Motion sensing for “TIME PERIOD B”.

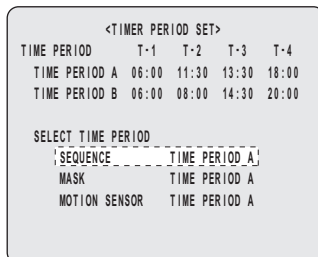

- 1** Turn the jog dial to move the cursor to “SEQUENCE” within “SELECT TIME PERIOD”, and then turn the shuttle dial clockwise.

“TIME PERIOD A” flashes.



- 2** Turn the jog dial to select “TIME PERIOD A”, and then turn the shuttle dial clockwise.

The cursor moves to “MASK”.

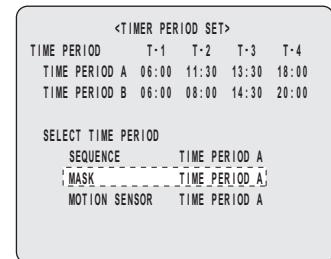

- 3** Set the time period for “MASK” and “MOTION SENSOR” in the same way.

- 4** Press the [EXIT/OSD] button.

The setting procedure is ended and the display returns to the normal screen.

Automatic selection, masking, and motion sensors are all set to “TIME PERIOD A” by default.

EXIT/OSD



NOTE

- As a result of the above operations, “SEQUENCE” are updated using main monitor and monitor 2 settings on P.102; “MASK” are updated using mask settings from on P.104; and “MOTION SENSOR” are updated using motion sensor settings on P.81.

Main Menu

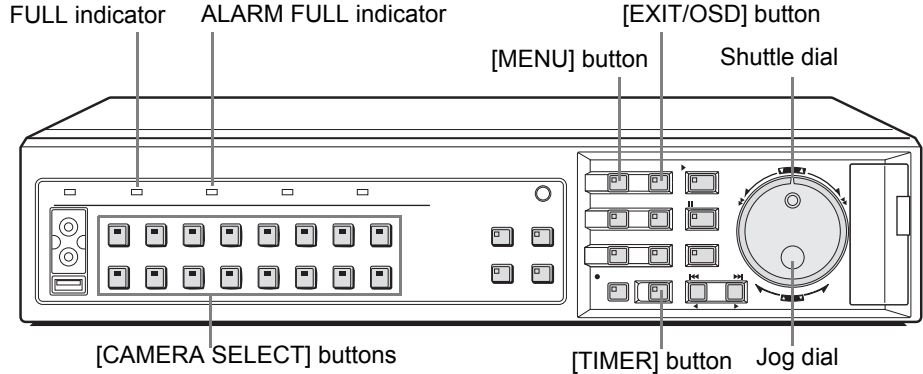
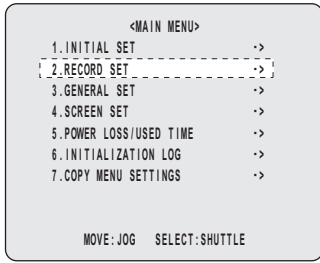

Settings for recording

The <RECORD SET> is used to make the following settings.

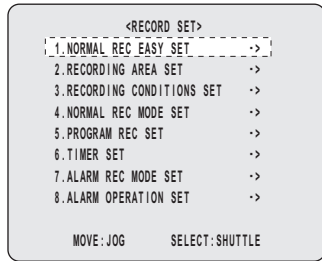

Setting	Description	Ref
1	<p><NORMAL REC EASY SET> Makes basic settings based on a number of days or a rate.</p>	P.60
2	<p><RECORDING AREA SET> Displays the total capacity of the hard disk. Sets the normal recording area, the alarm recording area, and the archive area.</p>	P.64
3	<p><RECORDING CONDITIONS SET> Sets whether overwriting is to be performed (by deleting old video) or recording is to be stopped when any of the hard disk's recording areas become full. Also sets the auto delete and series recording.</p>	P.67
4	<p><NORMAL REC MODE SET> Sets the picture quality, audio recording, the recording rate, and the program period.</p>	P.71
5	<p><PROGRAM REC SET> Sets program recording for cameras.</p>	P.73

Setting	Description	Ref
6	<p><TIMER SET> Makes timer settings so that operations can be started at a specified time or on a specified day.</p>	P.74
7	<p><ALARM REC MODE SET> Sets alarm recording, pre-alarm recording, and motion sensors.</p>	P.77
8	<p><ALARM OPERATION SET> Makes settings for operation and display upon detecting an alarm.</p>	P.84

Normal recording easy setup

Use the following procedures to make simple recording settings. Two different setting methods may be used -- one based on recording days; the other based on recording rate.

CAUTION

- Before making easy setup settings, connect the camera(s) to the digital video recorder and then always perform "CAMERA DETECT". (→P.54)
- When easy setup settings and individual settings are both set, the most recent settings override previous settings.
- Easy setup settings will be cancelled as a result of the following operations.
 - (1) When the number of cameras detected using "CAMERA DETECT" is greater or less than the number of cameras previously stored in the digital video recorder.
 - (2) When the setting for "PRE-ALARM RECORDING" from the <ALARM REC MODE SET> screen is changed.
 - (3) When menu settings are loaded from a CompactFlash card.
 - (4) When a new easy setup setting operation is carried out.
 - (5) When setting values are changed for normal recording or timer recording.
 - (6) When the area is changed using the <RECORDING AREA SET> screen.

1 Press the [MENU] button.

The MENU indicator lights up and the <MAIN MENU> is displayed.



2 Turn the jog dial to select "2. RECORD SET", and then turn the shuttle dial clockwise.

The <RECORD SET> screen is displayed.

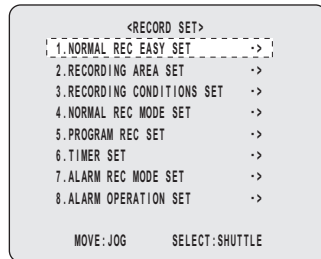

3 Turn the jog dial to select "1. NORMAL REC EASY SET", and then turn the shuttle dial clockwise.

The <NORMAL REC EASY SET> screen is displayed.

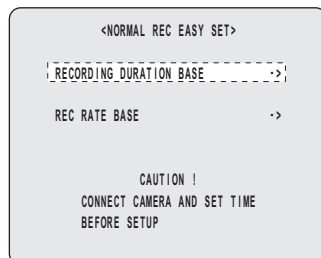

Setting based on recording days

4 Turn the jog dial to select "RECORDING DURATION BASE", and then turn the shuttle dial clockwise.

The <RECORDING DURATION BASE> screen is displayed with the cursor positioned on "RECORDING DURATION".

The number of detected cameras is indicated by "NUMBER OF CAMERAS".

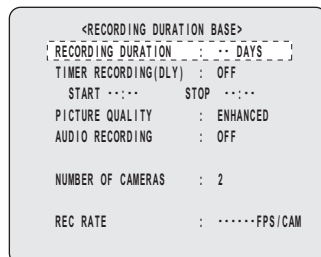

! CAUTION

- Confirm that the number of cameras connected to the digital video recorder is the same as the number of displayed recording cameras. If this is not the case, check the wiring between cameras and the digital video recorder and then carry out "CAMERA DETECT". (→P.54)

5 Turn the shuttle dial clockwise.

"1" flashes.



6 Set RECORDING DURATION with the jog dial or numeric keys and turn the shuttle dial clockwise.

The cursor moves to "TIMER RECORDING (DLY)".

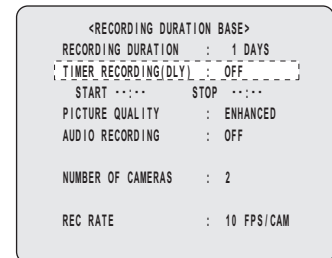

7 Turn the shuttle dial clockwise.

"OFF" flashes.



8 To activate timer operation, turn the jog dial to select “ON”, and then turn the shuttle dial clockwise.

The cursor moves to “START”.

If timer recording has been set to “ON”, set the timer’s “START” and “STOP” with the jog dial or numeric keys.

<RECORDING DURATION BASE>	
RECORDING DURATION	: 1 DAYS
TIMER RECORDING(DLY)	: ON
START	STOP
PICTURE QUALITY	: ENHANCED
AUDIO RECORDING	: OFF
NUMBER OF CAMERAS	: 2
REC RATE	: 10 FPS/CAM

The following settings are carried out with the shuttle dial and jog dial.

- Vertical cursor movement: Turn the jog dial.
- Cursor movement to the right: Turn the shuttle dial clockwise.
- Modification of values: Turn the shuttle dial clockwise, and then with the setting value flashing, turn the jog dial.
- Confirmation of values: Turn the shuttle dial clockwise.

9 Set “PICTURE QUALITY”.

<RECORDING DURATION BASE>	
RECORDING DURATION	: 1 DAYS
TIMER RECORDING(DLY)	: OFF
START	STOP
PICTURE QUALITY	: ENHANCED
AUDIO RECORDING	: OFF
NUMBER OF CAMERAS	: 2
REC RATE	: 10 FPS/CAM

[Settings] (◆ indicates default setting)

Setting	Description
BASIC (BA)	15 kB
NORMAL (NO)	22 kB
◆ ENHANCED(EN)	30 kB
FINE (FI)	42 kB
SUPER FINE (SF)	50 kB

10 Set “AUDIO RECORDING”.

Example: ON

<RECORDING DURATION BASE>	
RECORDING DURATION	: 1 DAYS
TIMER RECORDING(DLY)	: OFF
START	STOP
PICTURE QUALITY	: ENHANCED
AUDIO RECORDING	: OFF
NUMBER OF CAMERAS	: 2
REC RATE	: 10 FPS/CAM

[Settings] (◆ indicates default setting)

Setting	Description
◆ OFF	Audio recording is not carried out.
ON	Audio recording is carried out.

NOTE

- Audio recording can only be specified when the total recording rate for all cameras is 1.00 FPS or greater.
- When set to “ON”, the letter “A (indicating that audio will be recorded)” is displayed in front of recording rate. As both video and audio will be stored in the normal recording area, this area’s overall capacity will reduce accordingly.

11 Turn the shuttle dial counter-clockwise.

The <WARNING> screen is displayed.

<WARNING>	
REC RATE SETTING IN THE MENU WILL BE AUTOMATICALLY ADJUSTED.	
ARE YOU SURE ?	
NO	
CHANGE: JOG	SET: SHUTTLE

12 Turn the jog dial to select “YES”, and then turn the shuttle dial clockwise.

The display returns to the <NORMAL REC EASY SET> screen.

13 Press the [EXIT/OSD] button.

The setting procedure is ended and the display returns to the normal screen.

EXIT/OSD



! CAUTION

- The recording rate is automatically calculated based on recording settings and the number of connected cameras, and this is indicated by “REC RATE”. All cameras will record at this rate. If a valid figure cannot be calculated, “ERROR!” will be displayed.
- When easy setup settings and individual settings are both set, the most recent settings override previous settings.
- Easy setup settings cannot be used with program recording or day-specific timer recording.

Setting based on recording rate

4 Turn the jog dial to select “REC RATE BASE”, and then turn the shuttle dial clockwise.

The <REC RATE BASE> screen is displayed with the cursor positioned on “REC RATE”.

The number of detected cameras is indicated by “NUMBER OF CAMERAS”.

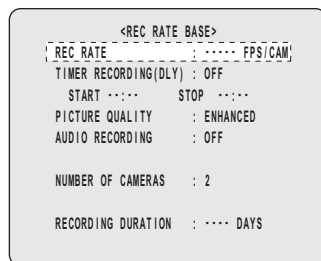
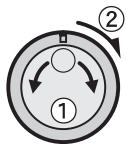

! CAUTION

- Confirm that the number of cameras connected to the digital video recorder is the same as the number of displayed recording cameras. If this is not the case, check the wiring between cameras and the digital video recorder and then carry out “CAMERA DETECT”. (→P.54)

5 Turn the shuttle dial clockwise.

“30.000” flashes.



6 Turn the jog dial to select “REC RATE”, and then turn the shuttle dial clockwise.

Set the recording rate for each individual camera. The cursor moves to “TIMER RECORDING (DLY)”.

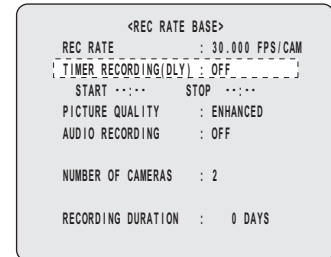

7 Turn the shuttle dial clockwise.

“OFF” flashes.

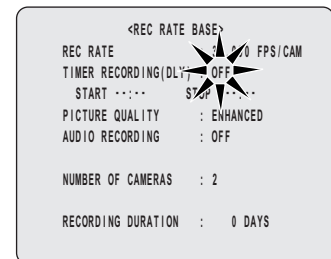

8 To activate timer operation, turn the jog dial to select “ON”, and then turn the shuttle dial clockwise.

The cursor moves to “START”.

If timer recording has been set to “ON”, set the timer’s “START” and “STOP” with the jog dial or numeric keys.

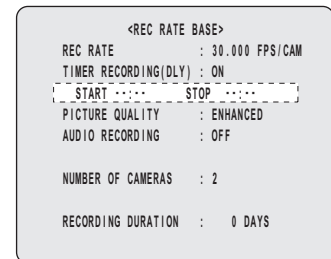

The following settings are carried out with the shuttle dial and jog dial.

- Vertical cursor movement: Turn the jog dial.
- Cursor movement to the right: Turn the shuttle dial clockwise.
- Modification of values: Turn the shuttle dial clockwise, and then with the setting value flashing, turn the jog dial.
- Confirmation of values: Turn the shuttle dial clockwise.

9 Set “PICTURE QUALITY”.

See P.62.

10 Set "AUDIO RECORDING".

See P.62.

11 Turn the shuttle dial counter-clockwise.

The <WARNING> screen is displayed.

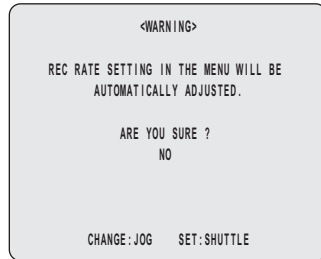

12 Turn the jog dial to select "YES", and then turn the shuttle dial clockwise.

The display returns to the <NORMAL REC EASY SET> screen.

13 Press the [EXIT/OSD] button.

The setting procedure is ended and the display returns to the normal screen.



! CAUTION

- The recording rate is automatically calculated based on recording settings and the number of connected cameras, and this is indicated by "RECORDING DURATION". If a valid figure cannot be calculated, "ERROR!" will be displayed.
- When simple recording settings and individual settings are both set, the most recent settings override previous settings.
- Easy setup settings cannot be used with program recording or day-specific timer recording.

Displaying the recording areas

Use the following procedures to confirm the hard disk's total recording capacity and also the allocation for each recording area.

1 Press the [MENU] button.

The MENU indicator lights up and the <MAIN MENU> is displayed.



2 Turn the jog dial to select "2.RECORD SET", and then turn the shuttle dial clockwise.

The <RECORD SET> screen is displayed.



3 Turn the jog dial to select "2. RECORDING AREA SET", and then turn the shuttle dial clockwise.

The <RECORDING AREA SET> screen is displayed.

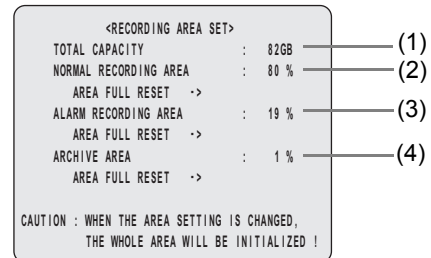

(1)	Displays the total capacity of the hard disk.	
(2)	Sets the capacity of the normal recording area.	Normal recording area
(3)	Sets the capacity of the alarm recording area.	Alarm recording area
(4)	Sets the capacity of the archive area.	Archive area

NOTE

Total capacity following hard disk expansion.

When "MIRRORING" (→P.93) is set using "4. HDD SET", the total capacity display will change as follows.

- If "MIRRORING" is "OFF", the capacity for hard-disk expansion is displayed.
- If "MIRRORING" is "ON", the capacity of the smallest hard-disk is displayed.
- The setting for the archive area cannot be modified directly.

When changes are made for the normal recording area or the alarm recording area, automatic settings will be made within a maximum range of 10 GB.

Default hard disk settings

By default, the normal recording area is set to 80%; the alarm recording area is set to 19%; and the archive area is set to 1%. The maximum capacity of the archive area is 10 GB.

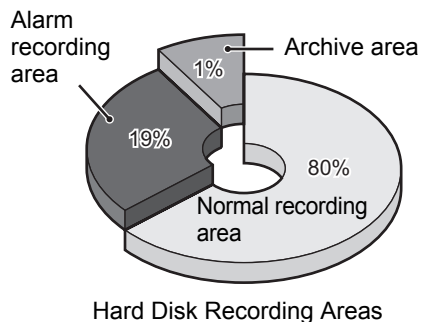

CAUTION

- When the recording area settings are changed, the disk is initialized and all current recordings are erased. It is important, therefore, to store recorded video on a PC or some other storage media before modifying recording areas.

Changing recording areas**Recording area allocations**

The highest possible allocation for the normal recording area and the alarm recording area is 99%.

The allocation for the archive area cannot be set manually. This allocation will be automatically set to at least 1%.

If the normal recording area is set to 0%

If set to 0%, it will not be possible to record video to the normal recording area. As video will only be recorded to the alarm recording area in this type of case, the area allocations should be reviewed and set accordingly.

CAUTION

- A maximum of 16,000 alarm recordings can be made on one hard disk. If hard disk expansion is carried out, this number can be increased to 32,000. Note, however, that menu settings and display content will have an effect on the maximum number of recordings that can be made in reality.
- **When the normal recording area is set to "0%"**
Alarm recording can be performed for as long as space is left in the alarm recording area. When searching for video, this area can be searched in the same way as the normal recording area using time/date searches, fast-forward play, and fast-reverse play. Alarm search, alarm thumbnail search, motion detection search, and alarm skip will not be available.

Example:

Setting the normal recording area to 50% and the alarm recording area to 49%

- 1 Turn the jog dial to select the "NORMAL RECORDING AREA", and then turn the shuttle dial clockwise.

"80%" flashes.



<RECORDING AREA SET>	
TOTAL CAPACITY	: 82GB
NORMAL RECORDING AREA	: 80%
AREA FULL RESET ->	
ALARM RECORDING AREA	: 19%
AREA FULL RESET ->	
ARCHIVE AREA	: 1%
AREA FULL RESET ->	

CAUTION : WHEN THE AREA SETTING IS CHANGED, THE WHOLE AREA WILL BE INITIALIZED !

- 2 Turn the jog dial to set "NORMAL RECORDING AREA" to 50%, and then turn the shuttle dial clockwise.

The cursor moves to "ALARM RECORDING AREA".

<RECORDING AREA SET>	
TOTAL CAPACITY	: 82GB
NORMAL RECORDING AREA	: 50%
AREA FULL RESET ->	
ALARM RECORDING AREA	: 49%
AREA FULL RESET ->	
ARCHIVE AREA	: 1%
AREA FULL RESET ->	

CAUTION : WHEN THE AREA SETTING IS CHANGED, THE WHOLE AREA WILL BE INITIALIZED !

The following settings are carried out with the shuttle dial and jog dial.

- Vertical cursor movement: Turn the jog dial.
- Cursor movement to the right: Turn the shuttle dial clockwise.
- Modification of values: Turn the shuttle dial clockwise, and then with the setting value flashing, turn the jog dial.
- Confirmation of values: Turn the shuttle dial clockwise.

3 Set “ALARM RECORDING AREA” to 49% and turn the shuttle dial to the right.

The cursor moves to “AREA FULL RESET.”

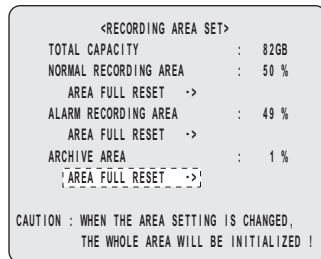

4 Turn the shuttle dial counter- clockwise.

The <WARNING> screen is displayed. The screen contains a message regarding initialization of the hard disk.



5 To change the recording area, turn the jog dial to display “YES”.



! CAUTION

- If the shuttle dial is turned clockwise while “NO” is selected, the <RECORDING AREA SET> screen will be displayed and the recording capacities will revert to their previous settings. In other words, the new settings will not be adopted.

6 Turn the shuttle dial clockwise.

- (1) The hard disk is initialized.



- (2) The <RECORD SET> screen appears and the modified recording capacities are adopted.

7 Press the [EXIT/OSD] button.

The setting procedure is ended and the display returns to the normal screen.



Setting overwrite permission

Set whether to continue recording and automatically overwrite data, or stop recording and not overwrite data when the normal recording area and alarm recording area become full (Setting recording conditions (→P.67)). Default setting is to automatically overwrite.

If the setting to not overwrite is selected, recording stops at the point where remaining capacity runs out. In this case, recording can be continued using the following steps to authorize overwriting.

Also, data is not overwritten automatically to archive area. Follow the steps below to authorize overwriting each time data is full.

1 Set the items in “Setting overwriting for the normal recording area”. (→P.67)

Set “OVERWRITE” to “OFF.”

- 2** Turn the jog dial to select “2. RECORDING AREA SET” from the <RECORD SET> screen, and then turn the shuttle dial clockwise.

The <RECORDING AREA SET> screen is displayed.

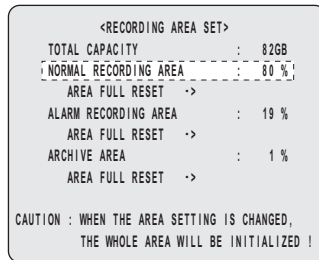

- 3** Turn the jog dial to select “AREA FULL RESET”, and then turn the shuttle dial clockwise.

“NO” on the <WARNING> screen flashes.

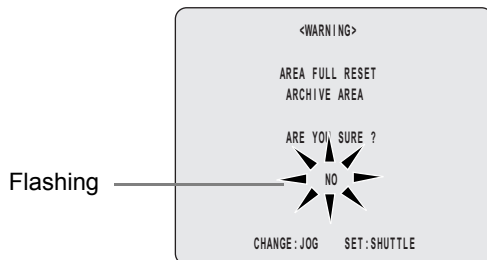

- 4** Turn the jog dial to select “YES”, and then turn the shuttle dial clockwise.

“NORMAL RECORDING AREA” is set to overwrite once.

- 5** Use the same procedure to make settings for the “ALARM RECORDING AREA”.

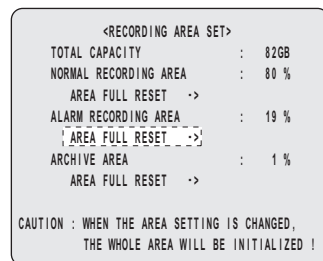

- 6** Press the [EXIT/OSD] button.

The setting procedure is ended and the display returns to the normal screen.



NOTE

- To perform overwriting automatically, set “OVERWRITE” for either “NORMAL RECORDING AREA” or “ALARM RECORDING AREA” from <RECORDING CONDITIONS SET> screen to “ON”. (→P.67)

CAUTION

- Whenever “AREA FULL RESET” is performed for “NORMAL RECORDING AREA” or “ALARM RECORDING AREA”, the video recorded in the corresponding area will be overwritten.
- Images in the archive area are erased when “AREA FULL RESET” is performed for the archive area.

Setting recording conditions

Use the following setting procedure to indicate whether overwriting is to be performed (deleting old video) or recording is to be stopped when any of the hard disk's recording areas become full.

Setting overwriting for the normal recording area

- 1** Turn the jog dial to select “OVERWRITE” for normal recording area, and then turn the shuttle dial clockwise.

“ON” flashes.

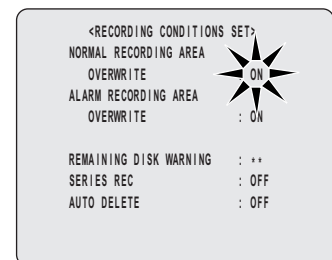

2 Turn the jog dial to select setting (OFF, for example), and then turn the shuttle dial clockwise.

“REMAINING DISK WARNING” changes to “1%” from “***”.

[Settings] (◆ indicates default setting)

Setting	Description
OFF	Recording is stopped when the normal recording area becomes full.
◆ON	Overwriting automatically starts from the beginning of the normal recording area when it becomes full.

<RECORDING CONDITIONS SET>

NORMAL RECORDING AREA
OVERWRITE : OFF

ALARM RECORDING AREA
OVERWRITE : ON

REMAINING DISK WARNING : 1 %

SERIES REC : OFF

AUTO DELETE : OFF

Remaining disk warning

NOTE

- If this is set to “OFF”, the FULL indicator or ALARM FULL indicator will start to flash when the remaining hard-disk capacity reaches the percentage set for “REMAINING DISK WARNING”.

3 Use the same procedure to set “ALARM RECORDING AREA” to “OFF”.

4 Turn the jog dial to select “REMAINING DISK WARNING”, and then turn the shuttle dial clockwise.

5 Turn the jog dial to set the remaining capacity, and then turn the shuttle dial clockwise.

The remaining capacity can be set anywhere between 1% (default) and 10%.

<RECORDING CONDITIONS SET>

NORMAL RECORDING AREA
OVERWRITE : OFF

ALARM RECORDING AREA
OVERWRITE : OFF

REMAINING DISK WARNING : 1 %

SERIES REC : OFF

AUTO DELETE : OFF

6 Press the [EXIT/OSD] button.

The setting procedure is ended and the display returns to the normal screen.



Turn “OVERWRITE” to “OFF” to display the remaining memory for the current recording area on the operating display.

Also, if remaining memory reaches the set percentage, the FULL indicator flashes for normal recording area and the ALARM FULL indicator flashes for the alarm recording area. When the remaining memory runs out, the indicator switches to a permanently lit condition and recording stops automatically.

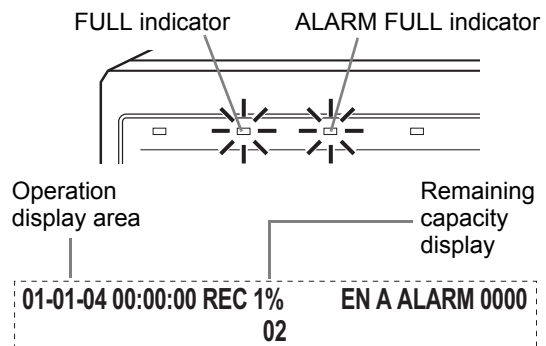

When the normal recording area or the alarm recording area become full

Make a new “AREA FULL RESET” setting for “NORMAL RECORDING AREA” and “ALARM RECORDING AREA” on the <RECORDING AREA SET> screen. (→P.66)

<RECORDING AREA SET>

TOTAL CAPACITY : 82GB

NORMAL RECORDING AREA : 80 %

AREA FULL RESET ->

ALARM RECORDING AREA : 19 %

AREA FULL RESET ->

ARCHIVE AREA : 1 %

AREA FULL RESET ->

CAUTION : WHEN THE AREA SETTING IS CHANGED,
THE WHOLE AREA WILL BE INITIALIZED !

Setting series recording

Use the following procedure to perform series recording when this digital video recorder is connected to other digital video recorders.

If series recording is set and normal recording area or alarm recording area remaining memory runs out, recording can be continued on a another digital video recorder. In doing so, recording to recording area with remaining memory is stopped.

Connect multiple digital video recorders and use series recording to record and save more video.

Connecting

1 Connecting series connection terminals.

Connect the series output terminal of the first recorder to the series input terminal of the second recorder, and from the series output terminal of the second recorder to the series input terminal of the third recorder and so on, in the order that you want to record.

To setup an overwriting series connection, connect the series output terminal of the last recorder to the series input terminal of the first.

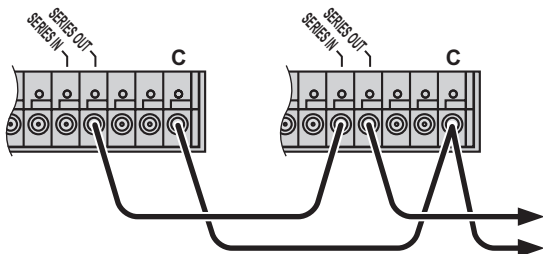

NOTE

- Use a connection cable less than 3 m in length.
- For an overwriting series connection, when the last digital video recorder runs out of memory, the first takes over recording.

2 Connecting VIDEO terminals.

Connect camera to the VIDEO IN terminal of the first recorder. Connect the VIDEO OUT terminal of the first recorder to the VIDEO IN terminal of the second recorder. Be sure to connect to the same channel. Connect to other digital video recorders in the following order using the VIDEO OUT terminal.

3 Connecting audio input terminals.

For audio recording, connect audio devices such as amps and microphones to the various digital audio recorder audio input terminals or microphone input terminals.

! CAUTION

- An audio device cannot be connected from the audio output terminal on one digital video recorder to the audio input terminal on the next as for video. Connect devices to each recorder directly.

4 Connecting alarm input and external timer input terminals.

For recording using external alarms or external timers, connect a sensor or timer device to the digital video recorder.

Connect to the external device with a cable, and connect the first recorder to the second recorder with another cable. Connect the cable from the first recorder to the second recorder terminal and then from the second recorder connect the cable to the third recorder and so on.

Settings

1 Set "OVERWRITE" for "NORMAL RECORDING AREA" and "ALARM RECORDING AREA" to "OFF".

```
<RECORDING CONDITIONS SET>
NORMAL RECORDING AREA
OVERWRITE          : OFF
ALARM RECORDING AREA
OVERWRITE          : OFF
REMAINING DISK WARNING : 1%
SERIES REC         : OFF
AUTO DELETE       : OFF
```

2 Set "SERIES RECORDING" to "ON".

```
<RECORDING CONDITIONS SET>
NORMAL RECORDING AREA
OVERWRITE          : OFF
ALARM RECORDING AREA
OVERWRITE          : OFF
REMAINING DISK WARNING : 1%
SERIES REC         : ON
AUTO DELETE       : OFF
```

3 Set depending on your recording needs.

Type of recording	Description
Normal recording	<ol style="list-style-type: none"> 1. Set image quality, audio recording, recording rate, and program recording with <NORMAL REC MODE SET>. 2. When using program recording, use <PROGRAM REC SET> to set recording rate for each camera.
Timer recording	<ol style="list-style-type: none"> 1. Set date, start and end time, program recording, and recording rate with <TIMER SET> and turn the timer "ON". 2. Set image quality and audio recording with <NORMAL REC MODE SET>. 3. When using program recording, use <PROGRAM REC SET> to set recording rate for each camera.
Normal recording + Alarm recording	<ol style="list-style-type: none"> 1. Set normal recording. 2. Set alarm recording with <ALARM REC MODE SET>. Set "ALARM RECORDING" to "ENABLED."
Timer recording + Alarm recording	<ol style="list-style-type: none"> 1. Set timer recording. 2. Set alarm recording with <ALARM REC MODE SET>. Set "ALARM RECORDING" to "AL-REC ON TIMER."

! CAUTION

- Alarm recording cannot be recorded alone. Set to combine with normal recording or timer recording.
- Normal recording and timer recording cannot be set simultaneously. If both are set, timer recording is enabled.

4 After setting, press the [EXIT/OSD] button to save setting items.

EXIT/OSD



5 Use <COPY MENU SETTINGS> to copy setting items to all connected digital video recorders.

Starting and stopping series recording

1 Perform the following operation on the first recorder to start recording.

Description	Operation
Using normal recording, or normal recording + alarm recording	Press the [REC/STOP] button
Using timer recording, or timer recording + alarm recording	Press the [TIMER] button

2 When the normal recording area or alarm recording area memory level falls to the set percentage, recording is stopped and automatically resumes on the next connected recorder. Likewise, recording will resume on the next connected recorder and so on.

! CAUTION

- Recording will stop if the following operations are performed on a DVR while recording.

Description	Operation
While normal recording, or normal recording + alarm recording	Press and hold the [REC/STOP] button
While timer recording, or timer recording + alarm recording	Press the [TIMER] button

- Set the security lock to avoid stopping series recording due to one of the above operations.
- If a recording is started by series recording, images saved to the normal recording area and alarm recording area are deleted. Backup important images before starting series recording.

Setting auto deleting

You can set a storage period for recorded data as described below. When the set period has expired, the corresponding data will be automatically deleted.

- 1 Turn the jog dial to select “AUTO DELETE”, and then turn the shuttle dial clockwise.

“OFF” flashes.

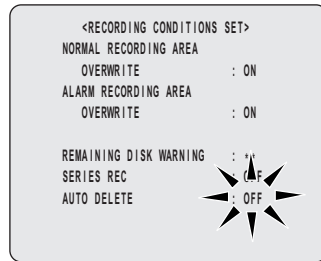

- 2 Turn the jog dial to select the storage period.

You can set the storage period for recorded data “OFF” or within a range of “1 DAYS” - “99 DAYS” (full days).

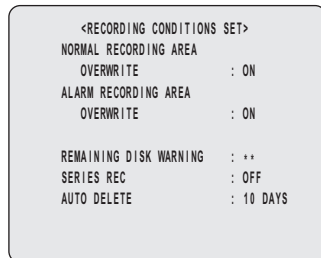

- 3 Turn the shuttle dial clockwise.

- 4 Press the [EXIT/OSD] button.

The setting procedure is ended and the display returns to the normal screen.



! CAUTION

- When setting has been completed, all data with expired storage periods will be deleted. Before setting, copy important data to the archive area or CompactFlash card.
- Data in the archive area cannot be auto deleted.

Setting normal recording

Use the following procedure to make normal recording settings for recording quality, audio recording, and recording rate. Alternatively, a program number set using “PROGRAM REC SET” can be specified to set these parameters.

- 1 Press the [MENU] button.

The MENU indicator lights up and the <MAIN MENU> is displayed.



- 2 Turn the jog dial to select “2. RECORD SET”, and then turn the shuttle dial clockwise.

The <RECORD SET> screen is displayed.



- 3 Turn the jog dial to select “4. NORMAL REC MODE SET”, and then turn the shuttle dial clockwise.

The <NORMAL REC MODE SET> screen is displayed.

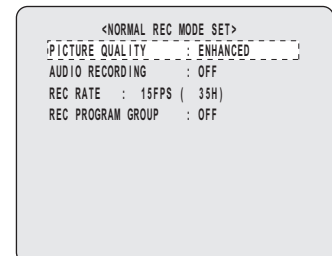

- 4 Turn the shuttle dial clockwise.

“ENHANCED” flashes (indicating enhanced quality recording).

5 Turn the jog dial to select “PICTURE QUALITY”, and then turn the shuttle dial clockwise.

```
<NORMAL REC MODE SET>
PICTURE QUALITY : ENHANCED
AUDIO RECORDING : OFF
REC RATE : 15FPS ( 35H)
REC PROGRAM GROUP : OFF
```

[Settings] (◆ indicates default setting)

Setting	Description
BASIC (BA)	15 kB
NORMAL (NO)	22 kB
◆ ENHANCED(EN)	30 kB
FINE (FI)	42 kB
SUPER FINE (SF)	50 kB

! CAUTION

- The file size is intended as a general guideline and actual sizes will depend on the recorded video.

The following settings are carried out using the shuttle dial and jog dial.

- Vertical cursor movement: Turn the jog dial.
- Cursor movement to the right: Turn the shuttle dial clockwise.
- Modification of values: Turn the shuttle dial clockwise, and then with the setting value flashing, turn the jog dial.
- Confirmation of values: Turn the shuttle dial clockwise.

6 Set “AUDIO RECORDING”.

(Default setting: OFF)

Example: ON

```
<NORMAL REC MODE SET>
PICTURE QUALITY : ENHANCED
AUDIO RECORDING : ON
REC RATE : A 15FPS ( 34H)
REC PROGRAM GROUP : OFF
```

NOTE

- Audio recording can only be specified when “REC RATE” is between A60 and A1 FPS.
- When set to “ON”, the letter “A (indicating that audio will be recorded)” is displayed in front of the recording rate. As both video and audio will be stored in the normal recording area, this area’s overall capacity will reduce accordingly.
- Audio will only be output during playback at the same rate as recording.
- Audio and video may be slightly out of synchrony in certain situations.

7 Set “REC RATE”.

(Default setting: 15 FPS)

Example: 7.5

Allowable recording time is dependent on the setting made for “PICTURE QUALITY”. For more details, see the “Table of recording rate and times” (→P.115).

```
<NORMAL REC MODE SET>
PICTURE QUALITY : ENHANCED
AUDIO RECORDING : ON
REC RATE : A 7.5FPS ( 66H)
REC PROGRAM GROUP : OFF
```

Allowable recording time

! CAUTION

- When pre-alarm recording is set to “ON”, the recording rate is limited to 30 FPS (and a setting of 60 FPS cannot be made).

8 Set “REC PROGRAM GROUP”.

See (→P.73) for more details regarding program recording.

Example: P-1

```
<NORMAL REC MODE SET>
PICTURE QUALITY : ENHANCED
AUDIO RECORDING : ON
REC RATE : ****FPS ( 65H)
REC PROGRAM GROUP : P-1
```

[Settings] (◆ indicates default setting)

Setting	Description
◆ OFF	Video from all cameras is recording at the same rate.
P-1	Used when recording with Program No. 1.
P-2	Used when recording with Program No. 2.
P-3	Used when recording with Program No. 3.
P-4	Used when recording with Program No. 4.

9 Press the [EXIT/OSD] button.

The setting procedure is ended and the display returns to the normal screen.

EXIT/OSD



Setting program recording

Use the following procedure to record from specified cameras. A total of four programs (No. 1 through No. 4) can be setup for this purpose. For example, Program No. 1 could be setup to record from cameras No. 1 through No. 4 only, whereas Program No. 2 could be setup to record from cameras No. 3 through No. 6. In addition, these programs can also be used for timer recording.

Example:

Setting Program No. 1 to record video from cameras No. 1 through No. 3

Cameras No. 1 through No. 9 are available for the DSR-3709.

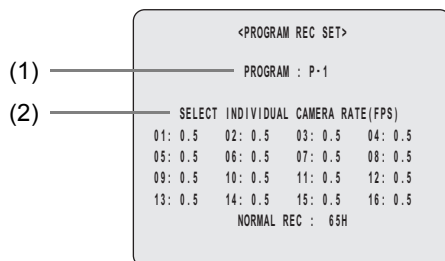

(1) PROGRAM

Selects Program No. 1 through Program No. 4.

(2) SELECT INDIVIDUAL CAMERA RATE

Sets which of the connected cameras to record from. Recording rates can also be set for each camera.

1 Press the [MENU] button, turn the jog dial to select “2. RECORD SET”, and then turn the shuttle dial clockwise.

The <RECORD SET> screen is displayed.

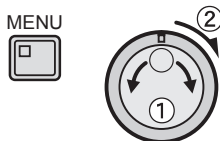

2 Turn the jog dial to select “5. PROGRAM REC SET”, and then turn the shuttle dial clockwise.

The <PROGRAM REC SET> screen is displayed with the cursor positioned on “PROGRAM”.

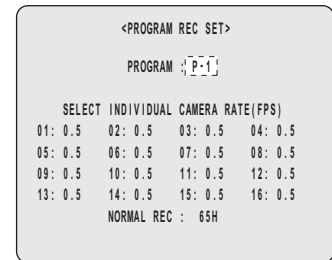

3 Turn the shuttle dial clockwise.

“P-1” flashes.

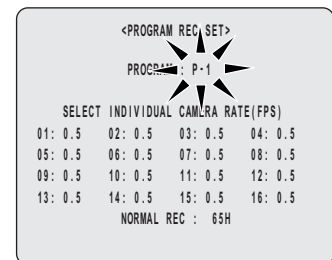

4 Turn the jog dial to select a program number (P-1, for example), and then turn the shuttle dial clockwise.

The cursor moves to “0.5” from “SELECT INDIVIDUAL CAMERA RATE (FPS)”.

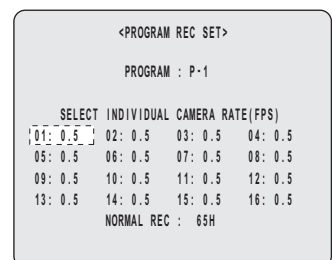

5 Turn the shuttle dial clockwise.

“0.5” (recording rate) flashes.

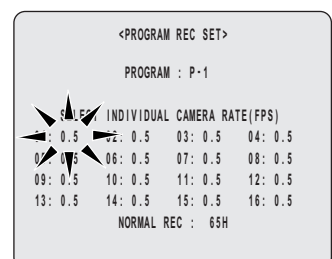

6 Turn the jog dial to select a recording rate (7.5, for example), and then turn the shuttle dial clockwise.

Camera No. 1 is now set to record at a rate of 7.5.
The cursor moves to "02".

Valid recording rates

30*, 15, 7.5, 3.75, 1.875, 1, 0.5, 0.33, 0.25, 0.2, 0.1, 0.05, 0.03, OFF (Unit: FPS)

* A selection cannot be made when pre-alarm recording has been set to "ON".

7 Set recording rates for Camera No. 2 and Camera No. 3 in the same way.

8 With the cursor flashing on "04" (camera number), turn the jog dial to select "OFF", and then turn the shuttle dial clockwise.

Video from Camera No. 4 will not be recorded.

9 Use the same procedure to set Camera No. 5 through Camera No. 16 to "OFF".

<PROGRAM REC SET>			
PROGRAM : P-1			
SELECT INDIVIDUAL CAMERA RATE(FPS)			
01: 7.5	02: 1	03: 1	04: OFF
05: OFF	06: OFF	07: OFF	08: OFF
09: OFF	10: OFF	11: OFF	12: OFF
13: OFF	14: OFF	15: OFF	16: OFF
NORMAL REC : 55H			

10 If necessary, use this procedure to setup other programs (i.e., No. 2 through No. 4).

11 Press the [EXIT/OSD] button.

The setting procedure is ended and the display returns to the normal screen.

EXIT/OSD



Timer settings

Use the following procedures to set recording start and stop times using the timer function.

Timer setting items

Timer setting items allow you to set times at which to start and stop recording or recording rate on each specified day of the week.

	(1)	(2)	(3)	(4)	(5)	(6)
	<TIMER SET>					
	WEEK	START	STOP	PROGRAM	FPS	SET
	SUN	OFF	15 FPS	OFF
	MON	OFF	15 FPS	OFF
	TUE	OFF	15 FPS	OFF
	WED	OFF	15 FPS	OFF
	THU	OFF	15 FPS	OFF
	FRI	OFF	15 FPS	OFF
(7)	SAT	OFF	15 FPS	OFF
	DLY	OFF	15 FPS	OFF
	EXT	OFF	15 FPS	OFF

(1) WEEK

These fields are used to select the days of the week for timer settings. When a day in the "WEEK" column is flashing, it can be set to another day. The 7th line (default: "SAT") and 8th line (default: "DLY") are used for timer recording settings of over 24 hours.

(2) START

These fields are used to enter the time (24-hour time) at which to start timer recording.

(3) STOP

These fields are used to enter the time (24-hour time) at which to stop timer recording.

If the stop and end times are on different days (i.e., midnight is included), a "T" will be displayed to the left of the end time.

(4) PROGRAM

These fields are used to enable timer recording using the program function "P-1" through "P-4". (→P.73)

(5) FPS

These fields are used to set the recording rate. No setting is necessary here when using program recording.

(6) SET

When set to "ON", timer is enabled.
When set to "OFF", timer is disabled.

(7) Settings for timer recording of over 24 hours

Use these lines for timer recording spanning more than 24 hours.

NOTE

- The settings made using <NORMAL REC MODE SET> are used to set quality and audio recording for timer recording. (→P.71)
- Set recording rate to above 1 FPS when performing audio recording.
- If the start and end times are on different days (i.e., midnight is included), a “T” will be displayed to the left of the end time.
- Ensure that start and end times are input using 24-hour notation.

Making timer reservations every day with the same duration and recording rate

Example:

Making a timer recording every day from 8:30 to 18:30 with the same recording rate.

- 1 Press the [MENU] button and turn the jog dial to select “2. RECORD SET”, and then turn the shuttle dial clockwise.

The <RECORD SET> screen is displayed.

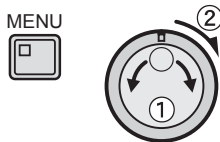

- 2 Turn the jog dial to select “6. TIMER SET”, and then turn the shuttle dial clockwise.

The <TIMER SET> screen is displayed.

The cursor moves to the “SUN” row.

<TIMER SET>						
WEEK	START	STOP	PROGRAM	FPS	SET	
SUN	08:30	18:30	OFF	15 FPS	ON	
MON	OFF	15 FPS	OFF	
TUE	OFF	15 FPS	OFF	
WED	OFF	15 FPS	OFF	
THU	OFF	15 FPS	OFF	
FRI	OFF	15 FPS	OFF	
SAT	OFF	15 FPS	OFF	
DLY	OFF	15 FPS	OFF	
EXT	OFF	15 FPS	OFF	

- 3 Turn the shuttle dial clockwise.

“SUN” from the “WEEK” column flashes.



- 4 Turn the jog dial to set “SUN” to “DLY”, and then turn the shuttle dial clockwise.

The start time flashes as “--:--”.

- 5 Repeat steps 3 and 4 to set the remaining items with the shuttle dial, jog dial, or numeric keys.

■ To change a displayed setting item

Turn the shuttle dial in the required direction to select the item to be changed, and then turn the jog dial to change the setting.

<TIMER SET>						
WEEK	START	STOP	PROGRAM	FPS	SET	
SUN	08:30	18:30	OFF	15 FPS	ON	
MON	OFF	15 FPS	OFF	
TUE	OFF	15 FPS	OFF	
WED	OFF	15 FPS	OFF	
THU	OFF	15 FPS	OFF	
FRI	OFF	15 FPS	OFF	
SAT	OFF	15 FPS	OFF	
DLY	OFF	15 FPS	OFF	
EXT	OFF	15 FPS	OFF	

- 6 Press the [EXIT/OSD] button when all of the necessary settings have been made.

The display returns to the normal screen.



■ To set different recording times and/or recording rates for each day of the week

Set the desired recording times and recording rate for each day.

NOTE

- If specific days are set as holidays, the operation for Sunday will be used on those days also. (→P.56)

! CAUTION

- If timer settings overlap, recording is performed in the following sequence.
Each daily reservation → DLY → EXT
Priority (high) ←—————→ (low)
- If a reservation for a particular day overlaps with a daily reservation, priority is given to that with the earliest start time. If both have the same start time, priority is given to that with the highest setting position in the menu.

To cancel all set timer reservations

- 1 Press the [MENU RESET] button with the <TIMER SET> screen displayed.

All setting items are cleared.

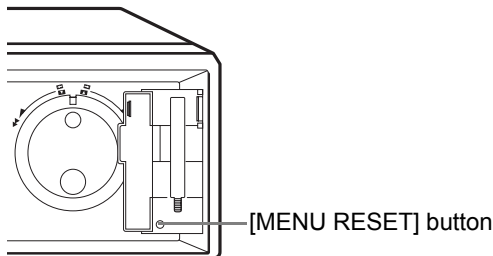

Timer reservations spanning more than 24 hours

Use the following procedures to set timer recordings spanning more than 24 hours. The 7th (SAT) and 8th (DLY) lines from the <TIMER SET> screen are used for this purpose.

Example:

Timer recording from 10:30 on Monday to 20:30 on Wednesday with a recording rate of 5 FPS.

- 1 Turn the jog dial to select line 7 (SAT), and then turn the shuttle dial clockwise.

"SAT" from the "WEEK" column flashes.

You can change the setting of the flashing item.

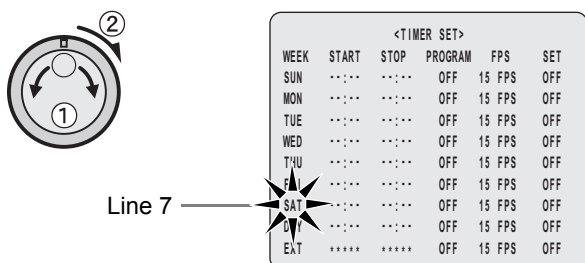

- 2 Make settings in the "WEEK" and "START" columns.

- (1) Turn the jog dial to change "SAT" to "MON", and then turn the shuttle dial clockwise.
"--" (time) under "START" flashes.

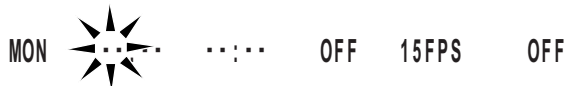

- (2) Set "--" to "10" with the jog dial or numeric keys and turn the shuttle dial clockwise.
- (3) Set "--" to "30" with the jog dial or numeric keys and turn the shuttle dial clockwise.



- 3 Turn the jog dial to change the stop time from "--" to "***", and then turn the shuttle dial clockwise.

The "DLY" item on line 8 automatically changes to "TUE" (i.e., the day after that set on line 7) and flashes. Items that do not need to be set are displayed as *.

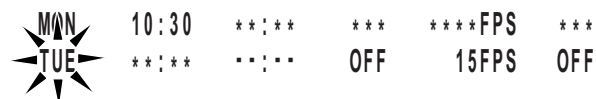

- 4 Set the day and time to stop recording using "WEEK" and "STOP", and also make settings for "FPS" and "SET".

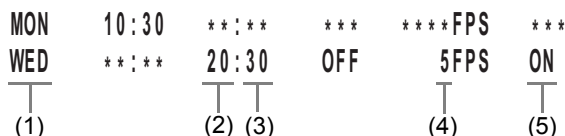

- (1) Turn the jog dial to change "TUE" to "WED", and then turn the shuttle dial clockwise.
- (2) Set "--" to "20" with the jog dial or numeric keys and turn the shuttle dial clockwise.
- (3) Set "--" to "30" with the jog dial or numeric keys and turn the shuttle dial clockwise.
- (4) Turn the jog dial to change "--" (recording rate) to "5", and then turn the shuttle dial clockwise.
- (5) Turn the jog dial to set "OFF" to "ON".

- 5 Press the [EXIT/OSD] button.

The setting procedure is ended and the display returns to the normal screen.



Timer recording using an external timer

Use the following procedure to control the start and end of recording in response to signals received via the EXT TIMER ON terminal on the rear of the digital video recorder.

Example:

Recording at a rate of 5 FPS using the EXT TIMER ON terminal

- 1 Connect the signal line from the external timer to the EXT TIMER ON terminal within the rear panel control terminal block.

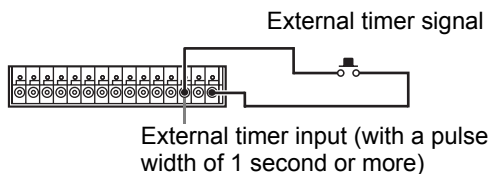

- 2 Turn the jog dial to select line 9 (EXT), and then turn the shuttle dial clockwise.

“OFF” for “PROGRAM” flashes.



<TIMER SET>					
WEEK	START	STOP	PROGRAM	FPS	SET
SUN	OFF	15 FPS	OFF
MON	OFF	15 FPS	OFF
TUE	OFF	15 FPS	OFF
WED	OFF	15 FPS	OFF
THU	OFF	15 FPS	OFF
FRI	OFF	15 FPS	OFF
SAT	OFF	15 FPS	OFF
DLY	OFF	15 FPS	OFF
EXT	*****	*****	OFF	5 FPS	OFF

- 3 Turn the jog dial to set “PROGRAM” to “OFF”, and then turn the shuttle dial clockwise.

“15” for “FPS” flashes.

EXT ***** ***** OFF **15 FPS** OFF

- 4 Turn the jog dial to set “FPS” to “5”, and then turn the shuttle dial clockwise.

“OFF” flashes.

EXT ***** ***** OFF **5 FPS** **OFF**

- 5 Turn the jog dial to change “OFF” to “ON”, and then turn the shuttle dial clockwise.

The cursor moves to line 1.

EXT ***** ***** OFF 5FPS ON

- 6 Press the [EXIT/OSD] button.

The setting is completed and turns to normal screen.



- 7 Press the [TIMER] button.



- The [TIMER] button lights up and the recorder enters timer recording standby mode.
- “REC” will be displayed within the operation display area while a signal is being received (with a pulse width of 1 second or more) via the EXT TIMER ON terminal, and monitoring video will be recorded in the normal recording area.

CAUTION

- External timer recording and normal timer recording can be combined.
- Connect the signal line from the external timer to the external timer recording terminal. External timer recording will not be possible until a timer is connected.

Setting alarm recording

To set alarm recording

Use the following procedure to select the recording picture quality, audio recording, and recording rate for the alarm recording area.

- 1 Press the [MENU] button and turn the jog dial to select “2. RECORD SET”, and then turn the shuttle dial clockwise.

The <RECORD SET> screen is displayed.



2 Turn the jog dial to select “7. ALARM REC MODE SET”, and then turn the shuttle dial clockwise.

The <ALARM REC MODE SET> screen is displayed.

The cursor moves to “ALARM RECORDING”.

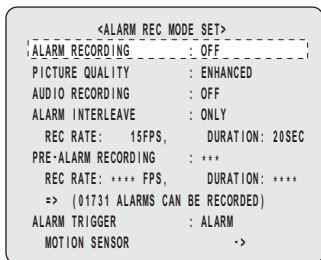

3 Turn the shuttle dial clockwise.

“OFF” flashes.

4 Turn the jog dial to select “ALARM RECORDING”, and then turn the shuttle dial clockwise.

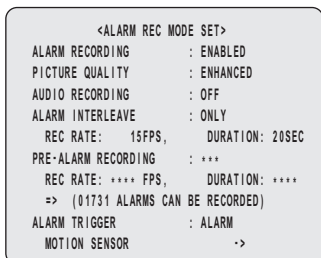

[Settings] (◆ indicates default setting)

Setting	Description
◆ OFF	Alarm recording is not carried out.
ENABLED	Alarm recording is always carried out, regardless of whether or not timer recording is being performed.
AL-REC ON TIMER	Alarm recording is carried out only during timer recording.
AL-REC OFF TIMER	Alarm recording is carried out only when timer recording is not being performed.
OLY AL-RC ON TMR	Alarm recording is carried out only for the amount of time set by the timer. Timer recording is not performed.

If “OLY AL-RC ON TMR” is set, timer recording becomes unavailable and the [TIMER] button is disabled.

The following settings are carried out with the shuttle dial and jog dial.

- Vertical cursor movement: Turn the jog dial.
- Cursor movement to the right: Turn the shuttle dial clockwise.
- Modification of values: Turn the shuttle dial clockwise, and then with the setting value flashing, turn the jog dial.
- Confirmation of values: Turn the shuttle dial clockwise.

5 Set “PICTURE QUALITY”.

[Settings] (◆ indicates default setting)

Setting	Description
BASIC (BA)	15 kB
NORMAL (NO)	22 kB
◆ ENHANCED(EN)	30 kB
FINE (FI)	42 kB
SUPER FINE (SF)	50 kB

! CAUTION

- The file size is intended as a general guideline and actual sizes will depend on the recorded video.

A guideline of the maximum number of alarm recordings under current settings is displayed in parentheses.

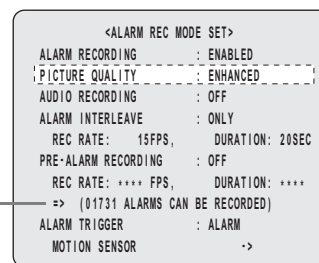

Maximum number of alarm recordings

6 Set “AUDIO RECORDING”.

When set to “ON”, the letter “A” (indicating that audio will be recorded) and the maximum number of alarm recordings is displayed in parenthesis.

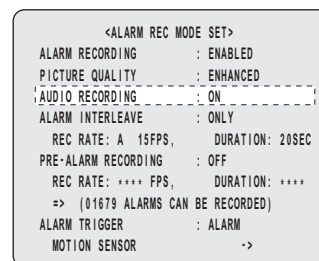

[Settings] (◆ indicates default setting)

Setting	Description
◆ OFF	Audio recording is not carried out.
ON	Audio recording is carried out.

[Setting conditions]

- Audio recording is possible when “REC RATE” is set to 1.00 FPS or greater.

7 Set "ALARM INTERLEAVE".

<ALARM REC MODE SET>	
ALARM RECORDING	: ENABLED
PICTURE QUALITY	: ENHANCED
AUDIO RECORDING	: ON
ALARM INTERLEAVE	: ONLY
REC RATE: A	15FPS, DURATION: 20SEC
PRE-ALARM RECORDING	: OFF
REC RATE: ****	FPS, DURATION: ****
=> (01679 ALARMS CAN BE RECORDED)	
ALARM TRIGGER	: ALARM
MOTION SENSOR	->

[Settings] (◆ indicates default setting)

Setting	Description
◆ ONLY	Video is recorded only from cameras with an alarm occurring.
SW	Recording is switched between camera video including an alarm and video from all connected cameras.

* Recording pattern for "SW" and "ONLY"

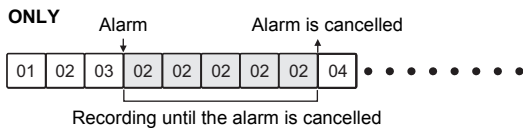
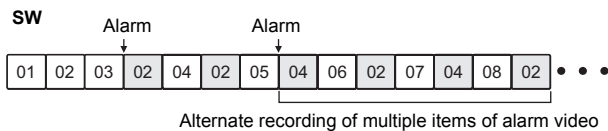

8 Set "REC RATE" and "DURATION".

The maximum number of recording alarms (shown in parentheses) changes in accordance with the new settings.

(Default setting for recording rate: 15 FPS)

(Default setting for duration: 20 SEC)

Maximum number of alarm recording

<ALARM REC MODE SET>	
ALARM RECORDING	: ENABLED
PICTURE QUALITY	: ENHANCED
AUDIO RECORDING	: ON
ALARM INTERLEAVE	: ONLY
REC RATE: A	15FPS, DURATION: 20SEC
PRE-ALARM RECORDING	: OFF
REC RATE: ****	FPS, DURATION: ****
=> (01679 ALARMS CAN BE RECORDED)	
ALARM TRIGGER	: ALARM
MOTION SENSOR	->

[Settings]

Item	Setting	Description
REC RATE	30 to 0.033 FPS	Sets the recording rate.
DURATION	5 SEC, 10 SEC, 20 SEC, 40 SEC, 1 MIN, 2 MIN, 3 MIN, 4 MIN, 5 MIN, 10 MIN, 15 MIN, CC*1	Sets the recording time per alarm.

*1 Operates while an alarm is being triggered. (5 sec. minimum)

When alarm recording settings have been completed

9 Press the [EXIT/OSD] button.

EXIT/OSD



The setting procedure is ended and the display returns to the normal screen.

"ALARM" and the number of alarms appear in the operation display area.

When an alarm occurs, the alarm display flashes.

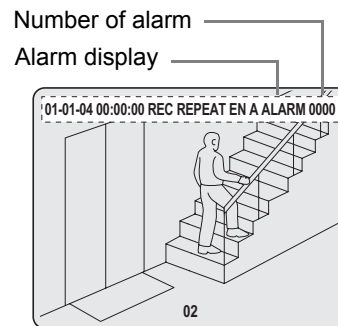

! CAUTION

- If a new alarm occurs during alarm recording, the alarm count is incremented in the same way as if two alarms had occurred. However, in cases where alarms occur consecutively on the same channel, alarm retrigger settings (→P.84) can be used to ensure that these are counted as one alarm only.

To set pre-alarm recording

! CAUTION

- Settings cannot be made for "PRE-ALARM RECORDING" when "ALARM RECORDING" is set to "OFF".

1 Turn the jog dial to select "PRE-ALARM RECORDING", and then turn the shuttle dial clockwise.

"OFF" flashes.



<ALARM REC MODE SET>	
ALARM RECORDING	: ENABLED
PICTURE QUALITY	: ENHANCED
AUDIO RECORDING	: ON
ALARM INTERLEAVE	: ONLY
REC RATE: A	15FPS, DURATION: 20SEC
PRE-ALARM RECORDING	: OFF
REC RATE: ****	FPS, DURATION: ****
=> (01679 ALARMS CAN BE RECORDED)	
ALARM TRIGGER	: ALARM
MOTION SENSOR	->

2 Turn the jog dial to change “OFF” to “ON”, and then turn the shuttle dial clockwise.

A message appears indicating automatic rate adjustment. “NO” flashes.

[Settings] (◆ indicates default setting)

Setting	Description
◆ OFF	Pre-alarm recording is not carried out.
ON	Pre-alarm recording is carried out.

3 Turn the jog dial to select “YES” for warning message, and then turn the shuttle dial clockwise.

The cursor moves to recording rate and duration.

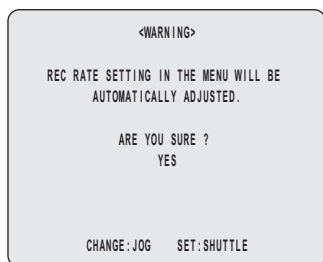

4 Turn the shuttle dial clockwise.

“REC RATE” for “PRE-ALARM RECORDING” flashes.

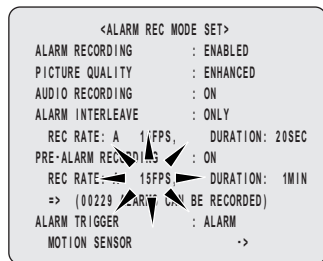

5 Turn the jog dial to set “REC RATE” (30 FPS, for example), and then turn the shuttle dial clockwise.

(Default setting: 15 FPS)

“DURATION” for “PRE-ALARM RECORDING” flashes.

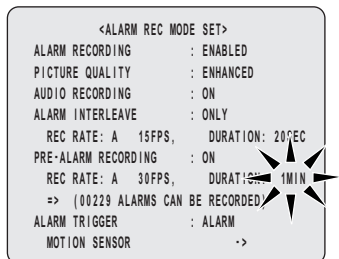

6 Turn the jog dial to set “DURATION” (10 SEC for example), and then turn the shuttle dial clockwise.

(Default setting: 1 MIN)

The cursor moves to “ALARM TRIGGER”.

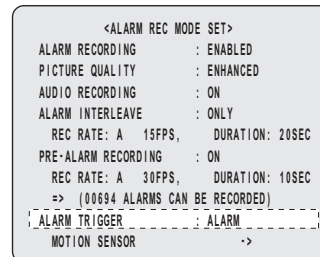

When pre-alarm recording settings have been completed

7 Press the [EXIT/OSD] button.



The setting procedure is ended and the display returns to the normal screen.

“PRE” appears in the operation display area. When an alarm occurs, “ALARM” is displayed.

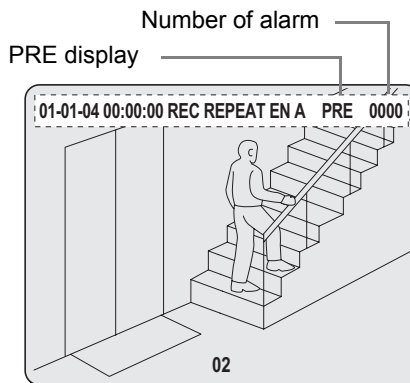

CAUTION

- Pre-alarm recording is carried out over the period before alarm input as set by “DURATION”. In order to playback pre-alarm recordings, carry out alarm search (using the [SEARCH] button). (→P.31)
As playback begins at the point of alarm occurrence, use the shuttle dial to move back into the area of pre-alarm recording.
- When normal recording and pre-alarm recording are performed simultaneously, audio will not be recorded together with pre-alarm video.

Setting the alarm trigger

Use this setting to indicate how alarms are to be detected.

- 1 Turn the jog dial to select “ALARM TRIGGER”, and then turn the shuttle dial clockwise.

“ALARM” flashes in the “ALARM TRIGGER” field.

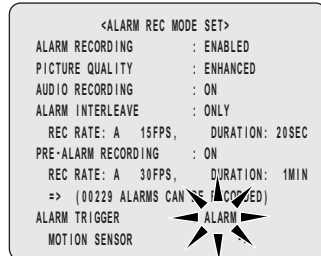

- 2 Turn the jog dial to select an alarm detection method, and then turn the shuttle dial clockwise.

[Settings] (◆ indicates default setting)

Setting	Description
◆ ALARM	Alarm recording is performed when an external alarm is generated (i.e., when a switch is attached to the alarm input terminal on the rear panel, and the switch is activated).
SENSOR	Alarm recording is performed when a motion sensor detects movement. See the section on setting motion sensors for more details.
ALARM AND SENSOR	Alarm recording is performed when both the external alarm and a motion sensor are activated simultaneously.
ALARM OR SENSOR	Alarm recording is performed when either the external alarm or a motion sensor is activated.

[Setting conditions]

- When sensor selection has been made (i.e., “SENSOR”, “ALARM AND SENSOR”, or “ALARM OR SENSOR”) it will be necessary to set the motion sensors.

NOTE

- The digital video recorder supports the coaxial alarm signal from coaxial superimposition cameras. When a coaxial alarm is input, it is treated as an external alarm.

Setting the motion sensors

Use the following procedure to set motion sensor on video from each camera so that alarms can be detected.

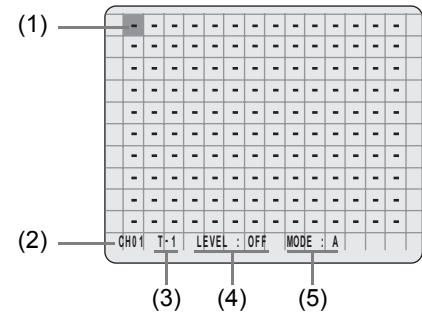

(1) Motion sensor setting

Displays changes in response to the sensor condition, and settings are made turning the jog dial.

-: Sensor off

A or B: Sensor on

(2) Camera number display

Changes when a [CAMERA SELECT] button is pressed. Use this item to select the camera for which motion sensors are to be setup.

(3) Time period

Select an interval as set using “TIME PERIOD” on P.57.

(4) LEVEL

Sets the sensitivity level of the motion sensors.

OFF: No motion sensor has been set.

1 to 10: A motion sensor is set. Lower values correspond to higher sensitivity levels and vice versa.

(5) MODE

Sets the detection method for the motion sensors.

(→P.83)

- Refer to “NAMES AND FUNCTIONS OF PARTS” for more details regarding operation of the jog dial and shuttle dial. (→P.9)

11 Turn the jog dial to set the sensitivity (OFF or 1 through 10), and then turn the shuttle dial clockwise.

The cursor moves to "MODE".

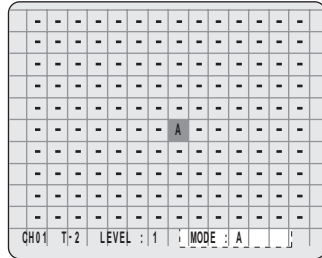

[Settings] (◆ indicates default setting)

Setting	Description
◆ OFF	Motion sensing is not carried out.
1 to 10	Motion sensing is carried out. Lower values correspond to higher sensitivities.

12 Turn the shuttle dial clockwise.

"A" flashes for the "MODE".

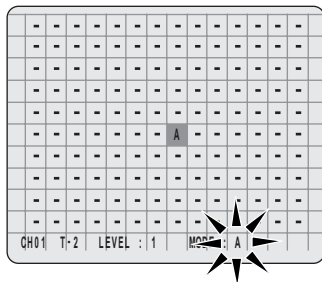

13 Turn the jog dial to select a "MODE", and then turn the shuttle dial clockwise.

The mode selection is confirmed and the cursor returns to the top left position.

[Settings] (◆ indicates default setting)

Setting	Description
◆ A	The motion sensor alarm is triggered when a moving object is detected in A.
B	The motion sensor alarm is triggered when a moving object is detected in B.
A AND B	The motion sensor alarm is triggered when a moving object is detected by a sensor in both A and B.
A AND NB	By setting A to important points (or suspected points of motion) and setting B to non-moving points, motion can be detected at point A even when the overall brightness changes and in other situations where motion at both A and B would normally be detected.
A TO B	The motion sensor alarm is triggered when an object is detected moving from A to B. (within 2 seconds from A to B)
B TO A	The motion sensor alarm is triggered when an object is detected moving from B to A. (within 2 seconds from B to A)
C	A motion sensor alarm is triggered when the entire image changes uniformly. In this way, sprays and other similar measures can be protected against. (Setting of sensor positions is unnecessary.)

14 Set "LEVEL" and "MODE" for T-2 through T-4 using the same procedure (i.e., steps 8 through 13).

! CAUTION

- Motion sensor positions are common for T-1 through T-4, and different settings cannot be made.
- Sensitivity levels and modes can be set individually for T-1 through T-4.

15 Turn the shuttle dial counter-clockwise.

Motion sensor settings are confirmed and the <ALARM REC MODE SET> screen is displayed once again.

■ To stop motion sensor recording

- (1) During recording, display the <ALARM REC MODE SET> screen and turn the shuttle dial clockwise.
- (2) The motion sensor screen is displayed. Turn the sensitivity level OFF.

NOTE

- The period for “T-1” through “T-4” as set in step 9 changes to that of “TIME PERIOD A” or “TIME PERIOD B” on P.57.
- When time period is unset, T-1 settings are enabled and T-2 through T-4 are disabled.

CAUTION

- The sensitivity level can be checked using the setting screen. When motion is detected, the sensor color changes from green to red, and a buzzer is sounded. If detection is too sensitive, an alarm can be triggered even by slight changes in lighting; accordingly, the sensitivity level should be set to match the camera location.

Setting alarm operation and display

- 1 Press the [MENU] button and turn the jog dial to select “2. RECORD SET”, and then turn the shuttle dial.

The <RECORD SET> screen is displayed.

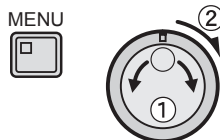

- 2 Turn the jog dial to select “8. ALARM OPERATION SET”, and then turn the shuttle dial clockwise.

The <ALARM OPERATION SET> screen is displayed with the cursor positioned on “ALARM RETRIGGER”.

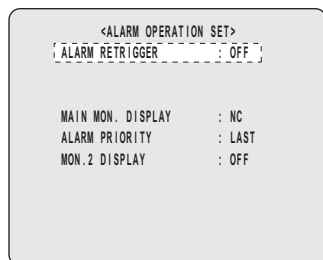

- 3 Turn the shuttle dial clockwise.

“OFF” flashes in the “ALARM RETRIGGER” field.

- 4 Turn the jog dial to set the alarm trigger to “ON”, and then turn the shuttle dial clockwise.

The cursor moves to “MAIN MON. DISPLAY”.

[Settings] (◆ indicates default setting)

Setting	Description
◆OFF	Even if a new alarm is received on the same channel during alarm recording, the duration is not extended.
ON	<p>If a new alarm is received on the same channel during alarm recording, the duration is extended and both alarms are treated as one. (Example: Input in the alarm sequence A → C) However, if the new alarm is on a different channel, the alarms are treated separately. (Example: Input in the alarm sequence A → B → C) Example:</p>

Setting alarm display

- 1 Turn the jog dial to select “MAIN MON. DISPLAY”, and then turn the shuttle dial clockwise.

“NC” starts to flash for “MAIN MON. DISPLAY”.

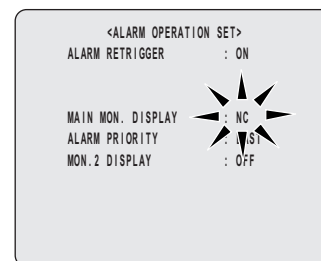
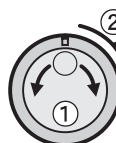

[Settings] (◆ indicates default setting)

Setting	Description
FULL	When an alarm is detected, the video on the channel containing the alarm is displayed in full screen format on the main monitor.
9	When an alarm is detected, a multi-9 screen display is presented on the main monitor.
16	When an alarm is detected, a multi-16 screen display is presented on the main monitor. (This can only be set on the DSR-3716.)
◆NC	The main monitor’s display does not change when an alarm is detected.

2 Turn the jog dial to set “MAIN MON. DISPLAY”, and then turn the shuttle dial clockwise.

The cursor moves to “ALARM PRIORITY”.

3 Turn the shuttle dial clockwise and turn the jog dial to set “ALARM PRIORITY”, and then turn the shuttle dial clockwise once again.

The cursor moves to “MON.2 DISPLAY”.

[Settings] (◆ indicates default setting)

Setting	Description
◆LAST	When a number of alarms are occurring, the most-recent alarm video is given priority.
FIRST	When a number of alarms are occurring, only the video for the first alarm is displayed. However, if the duration for the alarm with the first input expires, video for the next alarm will be displayed.
SWITCH	When a number of alarms are occurring, the display switches between the video from the corresponding cameras, showing each for one second.

! CAUTION

- After an alarm duration has ended, the display returns to the screen prior to alarm input.

4 Turn the shuttle dial clockwise and turn the jog dial to set “MON.2 DISPLAY” (ON/OFF), and then turn the shuttle dial clockwise.

The cursor moves to “ALARM RETRIGGER”.

[Settings] (◆ indicates default setting)

Setting	Description
ON	When an alarm occurs, the corresponding video is displayed on the monitor 2.
◆OFF	No alarm video is displayed on the monitor 2.

5 Press the [EXIT/OSD] button.

The setting procedure is ended and the display returns to the normal screen.



Canceling alarms

To forcibly cancel an alarm during alarm operation, press the [CAMERA SELECT] button for the camera inputting the alarm and hold it for approximately 3 seconds.

Alternatively, connect a switch between the alarm reset terminal and C (the grounded terminal), and turn on the switch to cancel any alarm that is occurring.

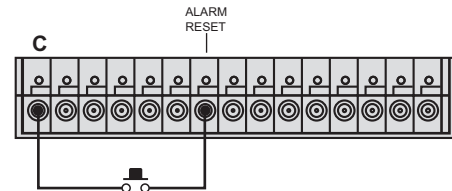

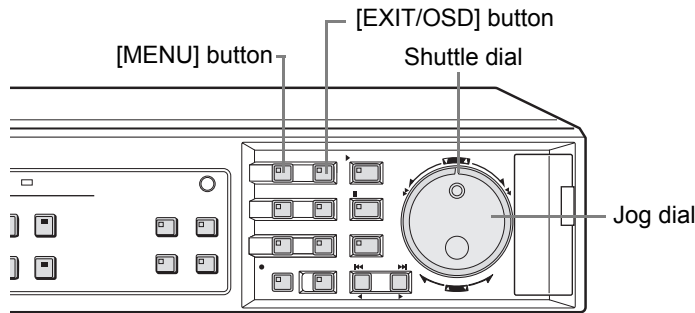
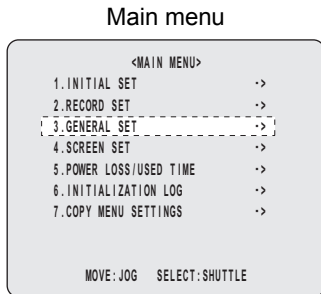

General settings

The <GENERAL SET> is used to make the following settings.



Setting	Description	Ref.
	<p><DISPLAY SET> Switches display items such as date and time from the operation display area. Settings can also be made for situations where video signals are lost.</p>	P.86
	<p><BUZZER SET> Turns the buzzer on or off.</p>	P.88
	<p><SECURITY LOCK SET> Lets you set passwords to prevent unauthorized users from operating the digital video recorder.</p>	P.89
	<p><HDD SET> Allows confirmation of hard disk capacity and performs initialization. Settings can also be made for mirroring.</p>	P.92
	<p><NETWORK SET> Allows the digital video recorder to be connected to a PC via a network.</p>	P.93

Setting	Description	Ref.
	<p><RS-485 SET> Lets you make settings when using RS-485.</p>	P.96
	<p><CAMERA CONTROL SET> Set when cameras with remote operation capability are connected.</p>	P.97

Setting data display

Use the following procedure to remove the date, time, or other information from the operation display area. All items are set to “ON” by default. Where necessary, the required items can be turned off.

- 1 Press the [MENU] button and turn the jog dial to select “3. GENERAL SET”, and then turn the shuttle dial clockwise.

The <GENERAL SET> screen is displayed.

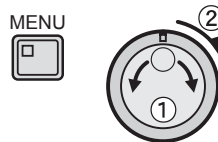

2 Turn the jog dial to select “1. DISPLAY SET”, and then turn the shuttle dial clockwise.

The <DISPLAY SET> screen is displayed.

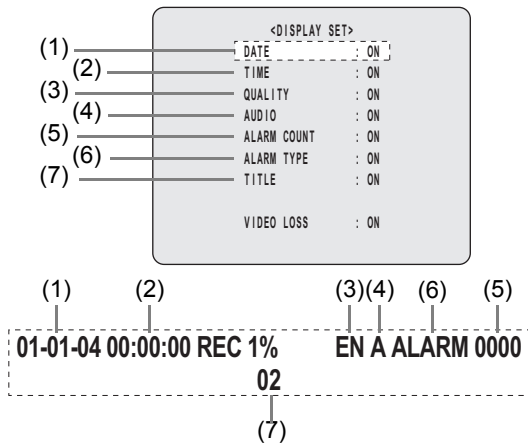

3 Turn the shuttle dial clockwise.

“ON” for the (1) “DATE” flashes. This can be set to “OFF” turning the jog dial to remove the date from the operation display area.

4 Turn the shuttle dial clockwise.

The cursor moves to the time entry.

The following settings are carried out with the shuttle dial and jog dial.

- Vertical cursor movement: Turn the jog dial.
- Cursor movement to the right: Turn the shuttle dial clockwise.
- Modification of values: Turn the shuttle dial clockwise, and then with the setting value flashing, turn the jog dial.
- Confirmation of values: Turn the shuttle dial clockwise.

5 Perform the following if so required.

- TIME (OFF):
Time is not displayed during recording or playback.
- QUALITY (OFF):
Picture quality mode is not displayed during recording or playback.
- AUDIO (OFF):
Audio recording settings are not displayed during recording or playback.
- ALARM COUNT (OFF):
The current number of alarms is not displayed.
- ALARM TYPE (OFF):
The type of alarm recording is not displayed.
- TITLE (OFF):
Camera titles are not displayed.

- The content of the operation display area changes when the setting for “ALARM RECORDING” (→P.77) from <ALARM REC MODE SET> is switched.

When turned “OFF”:

The alarm count and type are not displayed.

When turned “ENABLED”:

The operation display area changes as follows.

- “ALARM” is displayed when alarm video is recorded or played back.
- “PRE” is displayed when pre-alarm video is recorded or played back.
- “ARCHIV” is displayed for playback from the archive area.

6 Press the [EXIT/OSD] button.

The setting procedure is ended and the display returns to the normal screen.



NOTE

- A maximum of 9,999 alarms can be displayed in the operation display area. When this number is exceeded, the count returns to 0000.

Setting display for video loss

Use the following procedure to display “VIDEO LOSS!” when the camera video is interrupted.

1 Turn the jog dial to select “VIDEO LOSS”, and then turn the shuttle dial clockwise.



2 Turn the jog dial to display “ON”, and then turn the shuttle dial clockwise.

3 Press the [EXIT/OSD] button.

The setting procedure is ended and the display returns to the normal screen.



NOTE

- After "VIDEO LOSS" is detected, it can be cancelled by performing either of the following.
 - Input a video signal.
 - If no video input is required, use a [CAMERA SELECT] button to select the camera for which video loss was detected and then press and hold the same button.

Setting the buzzer

Use the following procedure to set a warning buzzer to sound for alarms or when hard disk space becomes insufficient.

- Press the [MENU] button, turn the jog dial to select "3. GENERAL SET", and then turn shuttle dial clockwise.

The <GENERAL SET> screen is displayed.

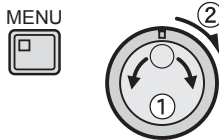

- Turn the jog dial to select "2. BUZZER SET", and then turn the shuttle dial clockwise.

The <BUZZER SET> screen is displayed.

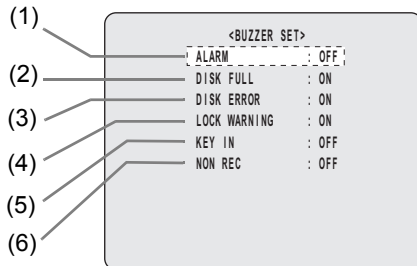

- ALARM (default setting: OFF)**
Sounds the buzzer when a alarm occurs.
- DISK FULL (default setting: ON)**
Sounds the buzzer when overwriting is forbidden and the hard disk capacity becomes insufficient.
- DISK ERROR (default setting: ON)**
Sounds a buzzer when a hard-disk error occurs.
- LOCK WARNING (default setting: ON)**
Sounds a buzzer if a button is pressed while the security lock is on. Specifically, the buzzer sounds twice with an interval of approximately 0.5 seconds.
- KEY IN (default setting: OFF)**
Sounds the buzzer when a button is pressed.
- NON REC (default setting: OFF)**
A buzzer is sounded upon loss of recording.

- Turn the shuttle dial clockwise.

"OFF" flashes for "ALARM".

- Turn the jog dial to display "ON", and then turn the shuttle dial clockwise.

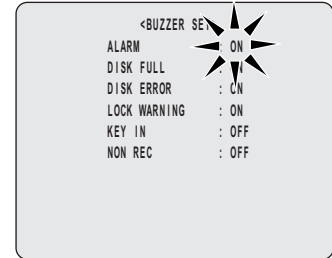

[Settings] (◆ indicates default setting)

Setting	Description
◆ OFF	The buzzer is not sounded when an alarm is generated.
ON	The buzzer is sounded when an alarm is generated.

Use the above procedure whenever necessary to change buzzer settings (ON or OFF).

- Press the [EXIT/OSD] button.

The setting procedure is ended and the display returns to the normal screen.



NOTE

- To stop a buzzer, press any button or turn either the jog dial or shuttle dial.

Setting the security lock

Use the procedures described below to set a passwords and to prevent unauthorized users from operating the digital video recorder. If a button is pressed while the security lock is in operation, a buzzer will be sounded. Be sure to make a note of the passwords that are set.

■ Operation after setting passwords

Two password types can be set, one for administrators and one for users. The table below gives typical password setting combinations and lists how the digital video recorder operates for each.

Setting item	ADMIN	ON				ON			
	USER	ON				OFF			
REC CONTROL	ADMIN	ADMIN	USER	USER	ADMIN	ADMIN	USER	USER	
CAMERA CONTROL	ADMIN	USER	USER	USER	ADMIN	USER	ADMIN	USER	
password	USER	USER	USER	USER	not entered	not entered	not entered	not entered	
Operation	LIVE	○	○	○	○	○	○	○	○
	PLAY	○	○	○	○	○	○	○	○
	PTZ	-	○	-	○	-	○	-	○
	REC	-	-	○	○	-	-	○	○
	MENU	-	-	-	-	-	-	-	-

Operation are as follows.

LIVE: [CAMERA SELECT], [QUAD], [MULTI], [MON2], [EXIT/OSD], [SEQUENCE] button operations
 PLAY: [PLAY/STOP], [ZOOM], [SEARCH], [COPY], [STILL], [SHUTTLE HOLD], [ALARM] button operations, jog/shuttle dial operations
 PTZ: PTZ camera controls operations
 REC: [REC/STOP], [TIMER] button operations
 MENU: [MENU], [MENU RESET] button operations

NOTE

- Enter the administrator password to enable all operations.
- If administrator and user are both "OFF", all operations are enabled no matter the security lock. (Default setting value)

Setting the administrator password

Passwords comprise between 4 and 8 alphanumeric characters.

Characters that can be entered in passwords: 0 to 9, A to Z

Example: Setting "123456AB" as a password

- 1 Press the [MENU] button and turn the jog dial to select "3. GENERAL SET", and then turn the shuttle dial clockwise.**

The <GENERAL SET> screen is displayed.

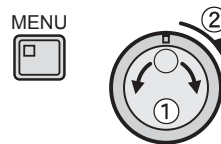

- 2 Turn the jog dial to select "3. SECURITY LOCK SET", and then turn the shuttle dial clockwise.**

The <SECURITY LOCK SET> screen is displayed.

The cursor moves to "ADMIN".



3 Turn the shuttle dial clockwise.

The first password character “-” flashes.

ADMIN  OFF

4 Set a character (0 to 9, A to Z) with the jog dial or numeric keys.

Example:

Display “1” with the jog dial or numeric keys.

ADMIN 1..... OFF

5 Turn the shuttle dial clockwise.

The second password character “-” flashes.

6 Use the same procedure to set “123456AB”.

NOTE

- **To set a 4-digit password**
Turn the shuttle dial clockwise when “-” for the fifth character is flashing.

7 Following this, turn the shuttle dial clockwise.

The cursor moves to “OFF” (flashing).

```

<SECURITY LOCK SET>
LEVEL  PASSWORD(4-8)  USE
ADMIN   123456AB    OFF
USER    .....      OFF
REC CONTROL : ADMIN
CAMERA CONTROL : ADMIN
  
```

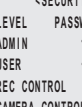

8 Turn the jog dial to select “ON”.

CAUTION

- If you select “OFF” for the “ADMIN” setting, you cannot set the “USER” password.

9 Turn the shuttle dial clockwise.

The cursor moves to “USER”.

If you do not want to set a user password, the password setting procedure can now be ended. Turn the jog dial to move the cursor to “REC CONTROL” so that authorization for recording and playback operations may be set.

Setting the user password

Example: Setting “AB123456”

1 Turn the jog dial to move the cursor to “USER”.

```

<SECURITY LOCK SET>
LEVEL  PASSWORD(4-8)  USE
ADMIN   123456AB    ON
USER    .....      OFF
REC CONTROL : ADMIN
CAMERA CONTROL : ADMIN
  
```

2 Turn the shuttle dial clockwise.

The first password entry bar “-” flashes.
Turn the jog dial to display “A”.

USER A..... OFF

3 Turn the jog dial clockwise.

The second password entry bar “-” flashes.
Turn the jog dial to display “B”.

Use the same procedure as for the administrator password to set “123456”.

4 Following this, turn the shuttle dial clockwise.

The cursor moves to “OFF” (flashing).

```

<SECURITY LOCK SET>
LEVEL  PASSWORD(4-8)  USE
ADMIN   123456AB    ON
USER    AB123456    OFF
REC CONTROL : ADMIN
CAMERA CONTROL : ADMIN
  
```



5 Turn the jog dial to select “ON”, and then turn the shuttle dial clockwise.

The cursor moves to “REC CONTROL”.

```

<SECURITY LOCK SET>
LEVEL  PASSWORD(4-8)  USE
ADMIN   123456AB    ON
USER    AB123456    ON
REC CONTROL : ADMIN
CAMERA CONTROL : ADMIN
  
```

Recording control settings

- 1 Turn the jog dial to move cursor to "REC CONTROL".



- 2 Turn the shuttle dial clockwise.

Turn the jog dial to select either "ADMIN" or "USER", and then turn the shuttle dial clockwise.

The cursor moves to "CAMERA CONTROL."

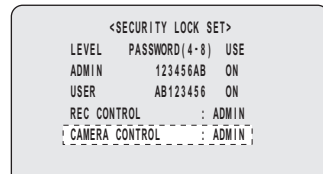

Camera control settings

- 1 Turn the jog dial to move cursor to "CAMERA CONTROL".

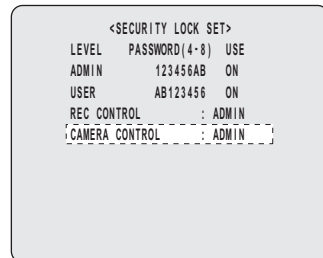

- 2 Turn the shuttle dial clockwise.

Turn the jog dial to select either "ADMIN" or "USER", and then turn the shuttle dial clockwise.

This completes the setting procedure.

- 3 Press the [EXIT/OSD] button.

The setting procedure is ended and the display returns to the normal screen.



Setting the security lock

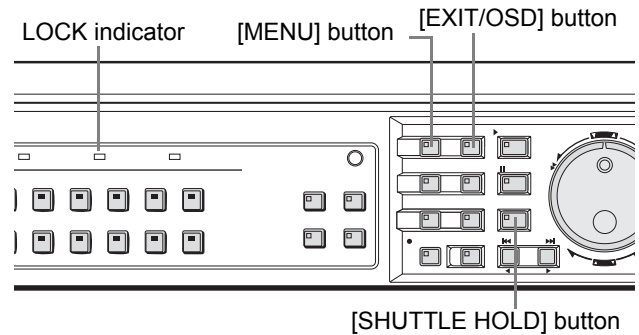

- 1 With the normal monitoring screen displayed, press the [SHUTTLE HOLD] button for approximately 3 seconds.

The LOCK indicator on the front panel lights up and a buzzer sounds to indicate activation of the security lock.



- 2 To confirm activation of this function, press the [MENU] button.

A password entry screen appears for about 5 seconds.

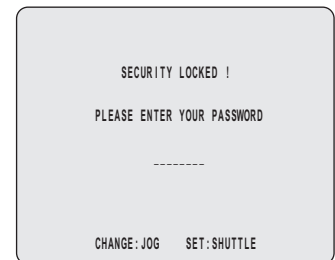

Canceling the security lock

- 3 Enter your password while the password entry screen is displayed.

Use the jog dial and the shuttle dial to perform this procedure.

! CAUTION

- Enter the password set for administrators or users (such as "123456AB"). Be sure to enter the correct password for the operation (s) to be carried out. (→P.89)

- 4 Turn the shuttle dial clockwise.

The security lock is cancelled and the display returns to the normal screen.

NOTE

- If an administrator password was entered, the security lock is cancelled and the indicator is turned off.
- If a user password was entered, the security lock is partially cancelled and the indicator remains lit.

Setting and initializing the hard disk

This section describes how to initialize and expand the hard disk.

When a single hard disk is installed, the hard disk capacity is displayed for DISK 1; when two hard disks are installed, the capacity is displayed for "DISK 1" and "DISK 2".

Initializing the hard disk

- 1 Press the [MENU] button and turn the jog dial to select "3. GENERAL SET", and then turn the shuttle dial clockwise.

The <GENERAL SET> screen is displayed.

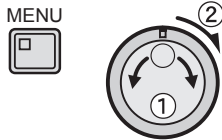

- 2 Turn the jog dial to select "4. HDD SET", and then turn the shuttle dial clockwise.

The <HDD SET> screen is displayed.
The cursor moves to "DISK INITIALIZE".



- 3 Turn the shuttle dial clockwise.

<WARNING> screen is displayed. "NO" flashes.



- 4 Turn the jog dial to select "YES".

- 5 Turn the shuttle dial clockwise.

The "HDD INITIALIZING!" screen is displayed, and the hard disk is initialized.

When initialization has been completed, the display returns to the <HDD SET> screen.



- 6 Press the [EXIT/OSD] button.

The setting procedure is ended and the display returns to the normal screen.



CAUTION

- Initialization of hard disk erases all contents.

Expanding the hard disk capacity

Please contact your local store or service center regarding hard disk expansion. A separately sold hard disk provided by Sanyo will be required in order to perform this procedure.

[Setting conditions]

- Initialization must always be carried out after hard disk expansion.

NOTE

The <HDD SET> screen

- **MIRRORING:** When hard disk expansion has been carried out, the same video can be recorded to both hard disks. Accordingly, if a problem occurs with recording to one of the hard disks, the <HDD SET> screen can be used to select the other hard disk for provision of readable data. When mirroring has been set, the recording rate is controlled automatically (i.e., set to half of the normal value) and the appropriate care must be taken.
- **PLAYBACK DRIVE:** This parameter is used together with "MIRRORING" and it indicates which of the two hard disks is to be used to provide recordings for playback.
- If a playback problem occurs while mirroring is turned on, change the hard disk used for playback.

CAUTION

- If hard disk expansion has been carried out, initialization is performed for both hard disks simultaneously, and all data will be lost.
- All important recordings should be copied to CompactFlash cards or another storage medium before hard disk expansion.
- If a hard disk not provided by Sanyo is used, Sanyo cannot be responsible for failures in performance or operation.

Network settings

Use the following procedure to make digital video recorder menu settings and to monitor video from a PC via a network (LAN).

A LAN cable must be connected to the LAN terminal on the rear panel before proceeding.

CAUTION

- When connecting the digital video recorder to a network, contact the network administrator in charge.

Making network connections

- **Connecting to a PC directly (without using a switch)**

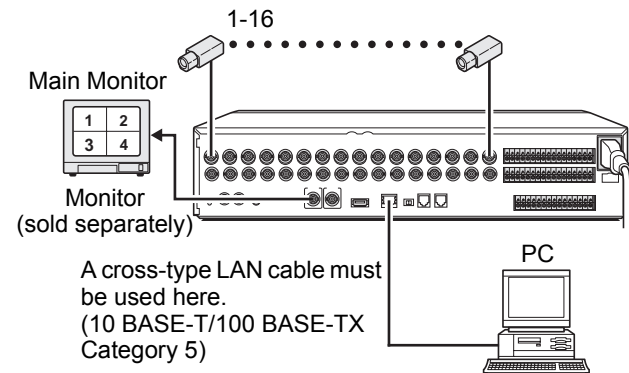

- **Connecting to an intranet (using a switch)**

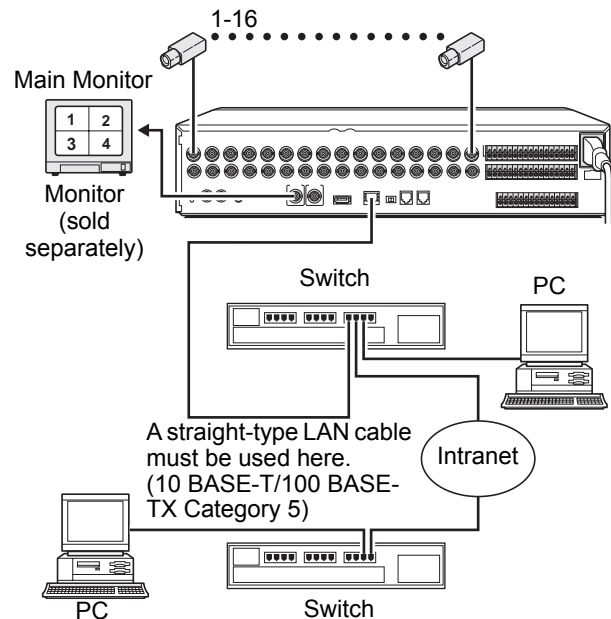

Making network settings

- 1 Press the [MENU] button and turn the jog dial to select “3. GENERAL SET”, and then turn the shuttle dial clockwise.

The <GENERAL SET> screen is displayed.

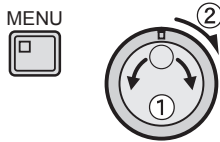

- 2 Turn the jog dial to select “5. NETWORK SET”, and then turn the shuttle dial clockwise.

The <NETWORK SET> screen is displayed.

<NETWORK SET>	
NETWORK CONTROL	: OFF
NETWORK STATUS	: ON
IP ADDRESS	: 192.168. 0. 1
SUBNET MASK	: 255.255.255. 0
GATEWAY	: 0. 0. 0. 0
PORT	: 00080
ID	: PASSWORD (4-8)
ID1	: 1111----
ID2	: 2222----
ID3	: 3333----

- 3 Turn the shuttle dial clockwise.

“OFF” flashes for “NETWORK CONTROL”.

- 4 Turn the jog dial to set to “ON (NETWORK)” or “ON (DVR)”, and then turn the shuttle dial clockwise.

The cursor moves to “NETWORK STATUS”.

<NETWORK SET>	
NETWORK CONTROL	: ON(NETWORK)
NETWORK STATUS	: ON
IP ADDRESS	: 192.168. 0. 1
SUBNET MASK	: 255.255.255. 0
GATEWAY	: 0. 0. 0. 0
PORT	: 00080
ID	: PASSWORD (4-8)
ID1	: 1111----
ID2	: 2222----
ID3	: 3333----

- 5 Turn the jog dial to select “ON” or “OFF”, and then turn the shuttle dial clockwise.

The cursor moves to “IP ADDRESS”.

<NETWORK SET>	
NETWORK CONTROL	: ON(NETWORK)
NETWORK STATUS	: ON
IP ADDRESS	: 192.168. 0. 1
SUBNET MASK	: 255.255.255. 0
GATEWAY	: 0. 0. 0. 0
PORT	: 00080
ID	: PASSWORD (4-8)
ID1	: 1111----
ID2	: 2222----
ID3	: 3333----

[Settings] (◆ indicates default setting)

Item	Setting	Description
NETWORK CONTROL	◆OFF	The digital video recorder cannot be controlled via a network.
	ON (NETWORK) ID: 1, 2, 3 Connection condition on DVR: Connection possible when not performing playback (incl. during copy), menu display, or camera controls.	Priority is given to operations on the PC. When playback is being performed on the PC, live video is displayed on the monitor connected to the digital video recorder. Furthermore, when connected to a PC, only operations for the switching of monitor display will be possible using the digital video recorder.
	ON (DVR) ID: 1 Connection condition on DVR: Connection possible when not performing playback (incl. during copy).	Priority is given to operations on the digital video recorder. Even if connected to a PC, recorder operations are given priority.
NETWORK STATUS	◆ON	During network connection, the message “NETWORK CONTROL” is displayed on the digital video recorder’s monitor.
	OFF	The message “NETWORK CONTROL” is not displayed on the digital video recorder’s monitor, even during network connection.

! CAUTION

- Network control is only possible when “NETWORK CONTROL” has been set to “ON”.
- In order to prevent network control while the digital video recorder is connected to a network, set “NETWORK CONTROL” to “OFF”.

The following settings are carried out with the shuttle dial, jog dial, or numeric keys.

- Vertical cursor movement: Turn the jog dial.
- Cursor movement to the right: Turn the shuttle dial clockwise.
- Modification of values : Turn the shuttle dial clockwise and when the setting value is flashing, modify the value with the jog dial or numeric keys.
- Confirmation of values : Turn the shuttle dial clockwise.

6 Set "IP ADDRESS".

(Default setting: 192. 168. 0. 1)

```

<NETWORK SET>
NETWORK CONTROL : ON(NETWORK)
NETWORK STATUS  : ON
IP ADDRESS      : 192.168. 0. 1
SUBNET MASK     : 255.255.255. 0
GATEWAY         : 0. 0. 0. 0
PORT           : 00080
  
```

7 Set "SUBNET MASK".

(Default setting: 255. 255. 255. 0)

```

<NETWORK SET>
NETWORK CONTROL : ON(NETWORK)
NETWORK STATUS  : ON
IP ADDRESS      : 192.168. 0. 1
SUBNET MASK     : 255.255.255. 0
GATEWAY         : 0. 0. 0. 0
PORT           : 00080
  
```

8 Set "GATEWAY".

(Default setting: 0. 0. 0. 0)

```

<NETWORK SET>
NETWORK CONTROL : ON(NETWORK)
NETWORK STATUS  : ON
IP ADDRESS      : 192.168. 0. 1
SUBNET MASK     : 255.255.255. 0
GATEWAY         : 0. 0. 0. 0
PORT           : 00080
  
```

9 Set "PORT".

(Default setting: 00080)

```

<NETWORK SET>
NETWORK CONTROL : ON(NETWORK)
NETWORK STATUS  : ON
IP ADDRESS      : 192.168. 0. 1
SUBNET MASK     : 255.255.255. 0
GATEWAY         : 0. 0. 0. 0
PORT           : 00080
  
```

Setting passwords for the network

Three access levels are setup for network connection, and a password is set for each. Passwords comprise between 4 and 8 alphanumeric characters.

! CAUTION

- "ID" or "PASSWORD (4-8)" at the top of the screen is the screen title. You cannot move the cursor to this item.

Example:

Setting "AB123456" to "ID1"

1 Turn the jog dial to select "ID 1".

```

<NETWORK SET>
NETWORK CONTROL : ON(NETWORK)
NETWORK STATUS  : ON
IP ADDRESS      : 192.168. 0. 1
SUBNET MASK     : 255.255.255. 0
GATEWAY         : 0. 0. 0. 0
PORT           : 00080
ID              : PASSWORD (4-8)
ID1             : 1111----
ID2             : 2222----
ID3             : 3333----
  
```

[Settings]

Setting	Description	Default setting
ID1	Allows video to be monitored via the network.	1111----
ID2	Allows video to be monitored and the playback or search/playback of recordings via the network.	2222----
ID3	Allows all of this recorder's operations and settings to be performed.	3333----

2 Turn the shuttle dial clockwise.

The first password entry item "1" flashes.

Characters that can be entered in passwords: 0 to 9, A to Z

3 Enter the password with the shuttle dial, jog dial, or numeric keys.

- (1) Turn the jog dial to select "A" and then turn the shuttle dial clockwise.
- (2) The second entry item "1" flashes. Turn the jog dial to select "B" and then turn the shuttle dial clockwise.
- (3) The third entry item "1" flashes. Repeat the same procedure to set "AB123456".

```

<NETWORK SET>
NETWORK CONTROL : ON(NETWORK)
NETWORK STATUS  : ON
IP ADDRESS      : 192.168. 0. 1
SUBNET MASK     : 255.255.255. 0
GATEWAY         : 0. 0. 0. 0
PORT           : 00080
ID              : PASSWORD (4-8)
ID1             : AB123456
ID2             : 2222----
ID3             : 3333----
  
```

- 4 Following this, turn the shuttle dial clockwise.
- 5 Where necessary, use the same procedure to set the "ID2" and "ID3" passwords.

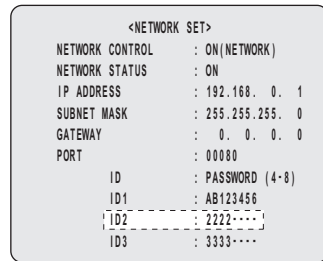

- 6 When setting has been completed, press the [EXIT/OSD] button.

The setting procedure is ended and the display returns to the normal screen.



Setting RS-485

Use the following procedure to make RS-485 settings. Connect the digital video recorder's RS-485 (A, B) control terminals on the rear panel to the system controller or similar device.

- 1 Press the [MENU] button and turn the jog dial to select "3. GENERAL SET", and then turn the shuttle dial clockwise.

The <GENERAL SET> screen appears.

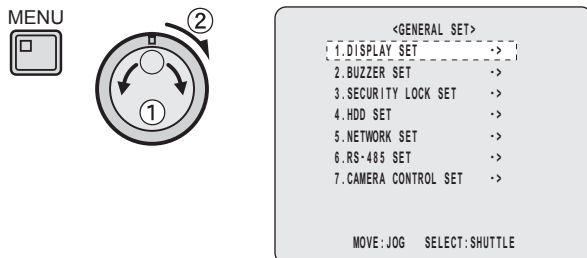

- 2 Turn the jog dial to select "6. RS-485 SET", and then turn the shuttle dial clockwise.

The <RS-485 SET> screen is displayed with the cursor positioned on "DATA SPEED".



- 3 Turn the shuttle dial clockwise and turn the jog dial to set "DATA SPEED", and then turn the shuttle dial clockwise.

The cursor moves to "STATUS INFO".



[Settings] (◆ indicates default setting)

Setting	Description
DATA SPEED	2400, 4800, 9600, ◆19200

- 4 Turn the shuttle dial clockwise and turn the jog dial to set "STATUS INFO", and then turn the shuttle dial clockwise.

The cursor moves to "ALARM INFO".

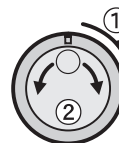

[Settings] (◆ indicates default setting)

Setting	Description
◆ON	Status information is transmitted.
OFF	Status information is not transmitted.

5 Turn the shuttle dial clockwise and turn the jog dial to set “ALARM INFO”, and then turn the shuttle dial clockwise.

The cursor moves to “ADDRESS”.

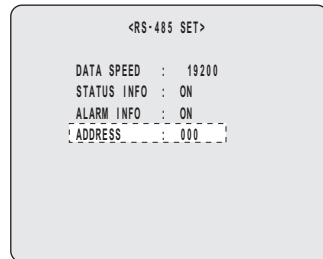

[Settings] (◆ indicates default setting)

Setting	Description
◆ON	Alarm information is transmitted.
OFF	Alarm information is not transmitted.

6 Turn the shuttle dial clockwise and set “ADDRESS” with the jog dial or numeric keys and then turn the shuttle dial clockwise.



[Setting conditions]

Addresses between “0” and “127” can be set for this unit.

7 Press the [EXIT/OSD] button.

The setting procedure is ended and the display returns to the normal screen.

EXIT/OSD



Setting camera control

The following procedure explains settings and operations of remote controllable cameras connected to the VIDEO IN terminals via coaxial cable.

1 Press the [MENU] button, turn the jog dial to select “3. GENERAL SET” and then turn the shuttle dial clockwise.

The <GENERAL SET> screen is displayed.

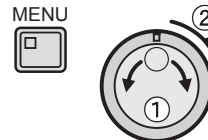

2 Turn the jog dial to select “7. CAMERA CONTROL SET” and then turn the shuttle dial clockwise.

The <CAMERA CONTROL SET> screen is displayed.

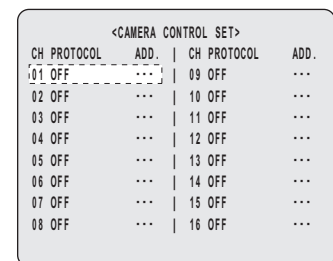
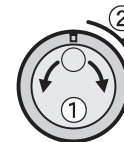

3 Turn the jog dial to select a channel connected to a camera and then turn the shuttle dial clockwise.

The “PROTOCOL” field flashes.

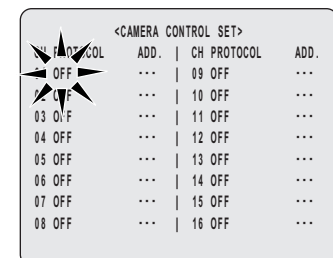
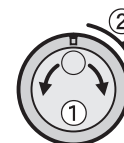

4 Turn the jog dial to select a protocol and then turn the shuttle dial clockwise.

The "ADD." column flashes.



<CAMERA CONTROL SET>			
CH PROTOCOL	ADD.	CH PROTOCOL	ADD.
01 SANYO COAX	...	09 OFF	...
02 OFF	...	10 OFF	...
03 OFF	...	11 OFF	...
04 OFF	...	12 OFF	...
05 OFF	...	13 OFF	...
06 OFF	...	14 OFF	...
07 OFF	...	15 OFF	...
08 OFF	...	16 OFF	...

[Settings] (◆ indicates default setting)

Setting	Description
◆ OFF	Camera control is disabled.
SANYO COAX	Camera control is enabled using SANYO (SSP) protocol coaxial superimposition.
SANYO RS485	Camera control is enabled using SANYO (SSP) protocol RS-485.
BBV COAX	Camera control is enabled using BBV protocol.
PELCO COAX	Camera control is enabled using PELCO protocol.

5 Set address (1 to 127) with the jog dial or numeric keys and turn the shuttle dial clockwise.

Address can be set only for "SANYO COAX" or "SANYO RS485" protocols.

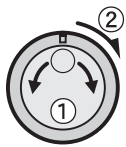

<CAMERA CONTROL SET>			
CH PROTOCOL	ADD.	CH PROTOCOL	ADD.
01 SANYO COAX	011	09 OFF	...
02 OFF	...	10 OFF	...
03 OFF	...	11 OFF	...
04 OFF	...	12 OFF	...
05 OFF	...	13 OFF	...
06 OFF	...	14 OFF	...
07 OFF	...	15 OFF	...
08 OFF	...	16 OFF	...

6 Press the [EXIT/OSD] button.

The setting procedure is ended and the display returns to the normal screen.



! CAUTION

- Camera control is only available for camera models supporting coaxial control or SANYO SSP control. Other companies' cameras such as RS-485 and RS-422 are unsupported. For supported cameras, check the Sanyo homepage or ask at your local Sanyo dealer.

Sanyo website URL:

<http://www.sanyosecurity.com>

Operating dome cameras with the digital video recorder

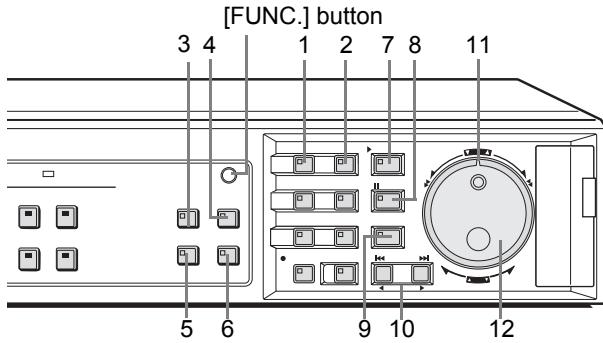

1 Press the [FUNC.] button.

The FUNC. indicator lights up and camera control mode is activated.



2 The buttons on the digital video recorder operate the dome cameras as follows.

In camera control mode the indicator lights up for all the following.

	Button	Button name in normal mode	Operation
1	[MENU] button	[MENU] button	Displays camera internal menu screen.
2	[ENTER] button	[EXIT/OSD] button	Selects in camera internal menu screen.
3	[PRESET] button	[QUAD] button	Switches to preset access mode (indicator flashes). Press [CAMERA SELECT] button to move the camera to preset position and disable preset access mode (indicator remains lit).
4	[AUTO PAN] button	[MULTI] button	Starts automatic panning. Perform another operation to stop automatic panning.
5	[SEQUENCE] button	[MON2] button	Starts automatic camera selection. Perform another operation to stop automatic camera selection.
6	[TOUR] button	[PLUS] button	Starts TOUR. Perform another operation to stop TOUR.
7	[AF] button	[PLAY/STOP] button	Use one-push auto-focus.

	Button	Button name in normal mode	Operation
8	[IRIS] button	[STILL] button	Switches to iris adjust mode (indicator flashes). Press [ZOOM/INFO ◀] button to close iris and [ZOOM/INFO ▶] to open iris. Press again to disable iris adjust mode (indicator remains lit).
9	[FOCUS] button	[SHUTTLE HOLD] button	Switches to focus adjust mode (indicator flashes). Press [ZOOM/INFO ◀] button to focus on nearby objects and [ZOOM/INFO ▶] to focus on far-off objects. Press again to disable focus adjust mode (indicator remains lit).
10	[ZOOM/INFO] button	[ALARM] button	Press [ZOOM/INFO ◀] to reduce screen. Press [ZOOM/INFO ▶] to enlarge screen. Use for operation when in iris adjust mode and focus adjust mode.
11	PAN	Shuttle dial	Pans faster the larger the arc, and slower the smaller the arc.
12	TILT	Jog dial	Turn to the right to tilt up and to the left to tilt down.

Finishing dome camera operation

3 Press the [FUNC.] button

The FUNC. indicator turns off and the unit returns to normal mode.

NOTE

- In the following cases, when [FUNC.] button is pressed, camera control mode does not start.
 - When displaying menu, search menu
 - During playback (including when paused or displaying copy menu)
 - When in quad screen display, multi screen display (9 screens/ 16 screens), or plus screen display
 - When zooming
 - When displaying automatic selection
 - When displaying monitor 2
- When PRESET, IRIS or FOCUS indicator is flashing (during operation) and another button is pressed, the operation is cancelled.
- [REC/STOP][TIMER] buttons perform the same operation as in normal mode.
- In the following cases, camera control mode is automatically disabled.
 - When no operation is performed for two minutes
 - When the alarm activates

Main Menu

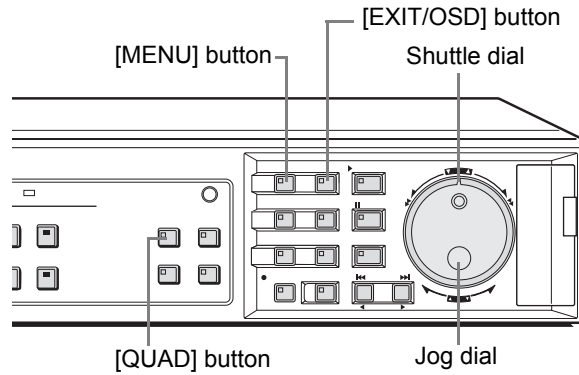
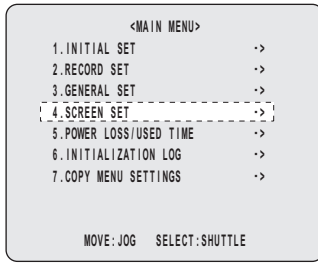

Setting quad, multi 9 and 16 display

Use the following procedure to change the display positions for cameras in quad, multi 9 and 16 screens.

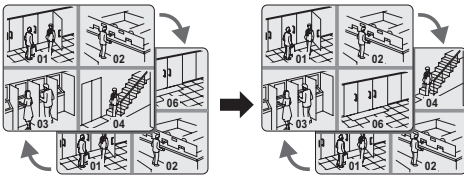

CAUTION

- Each camera can only be displayed in one position on any screenP.

Setting multi screen positions

Example: Displaying Camera No. 05 in quad position 01

On the DSR-3709, select cameras No. 01 through No. 09.

- Press the [MENU] button and turn the jog dial to select to “4. SCREEN SET”, and then turn the shuttle dial clockwise.

The <SCREEN SET> screen is displayed. The cursor moves to “1. MULTI SCREEN”.

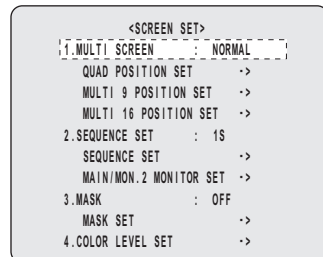

- Turn the shuttle dial clockwise.

“NORMAL” flashes for “1. MULTI SCREEN”.

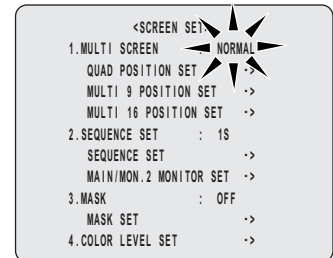

- Turn the jog dial to select “CHANGE”, and then turn the shuttle dial clockwise.

The cursor moves to “QUAD POSITION SET”.

[Settings] (◆ indicates default setting)

Setting	Description
◆NORMAL	The display sequence for cameras is not changed.
CHANGE	The display sequence for cameras is changed.

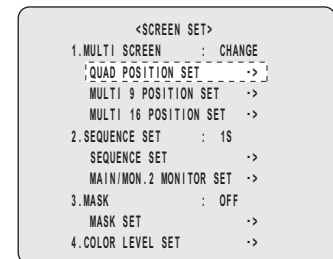

4 Turn the shuttle dial clockwise.

The <QUAD POSITION SET> screen is displayed.

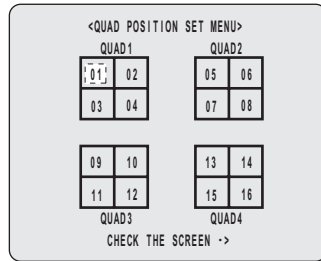

NOTE

- When arranging display position for 9 screen display select "MULTI 9 POSITION SET" and for 16 screen display select "MULTI 16 POSITION." 16 screen display can only be set on the DSR-3716.

5 Turn the jog dial to select "01" of "QUAD1", and then turn the shuttle dial clockwise.

"01" of "QUAD1" flashes.

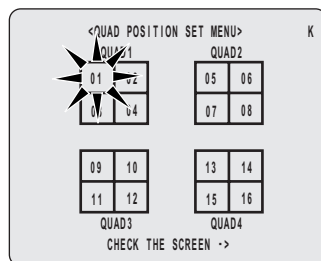

6 Set "05" with the jog dial or numeric keys and turn the shuttle dial to the right.

"01" of "QUAD1" changes to "05."

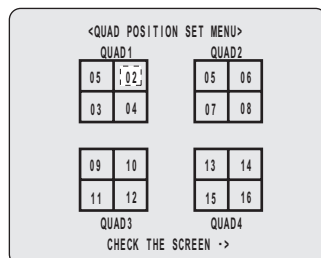

Checking modified screen positions

Select one of the "CHECK THE SCREEN" at the bottom of the modification screen to confirm that the modified screen positions are as intended.

7 Turn the jog dial to select "CHECK THE SCREEN" and then turn the shuttle dial clockwise.

QUAD 1 pattern is displayed. Pressing the [QUAD] button changes the display in the order QUAD B → C → D. Turn the shuttle dial counter-clockwise to return to the <QUAD POSITION SET> screen.

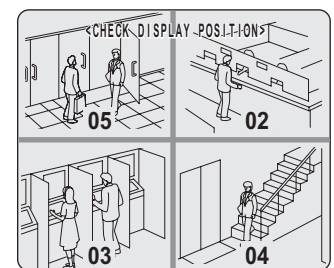
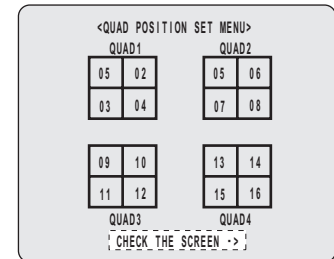

8 Press the [EXIT/OSD] button.

The setting procedure is ended and the display returns to the normal screen.

EXIT/OSD



Setting the period and monitors for automatic screen selection

Use the following procedure to scroll through video from all cameras using a specified period.
A switching time for automatic selection can only be set for full screen and quad display.

Setting the automatic selection period

Example:
Automatic switching of a full screen on the monitor every 5 seconds.

- 1 Press the [MENU] button and turn the jog dial to select "4. SCREEN SET", and then turn the shuttle dial clockwise.

The <SCREEN SET> screen is displayed. The cursor moves to "1. MULTI SCREEN".

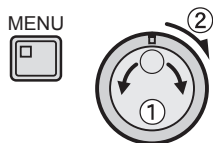

- 2 Turn the jog dial to move the cursor to "2. SEQUENCE SET", and then turn the shuttle dial clockwise.

"1S" flashes.

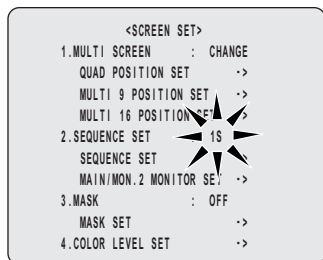

- 3 Turn the jog dial to set change the period to "5S", and then turn the shuttle dial clockwise.

Automatic selection is set to a period of 5 seconds.

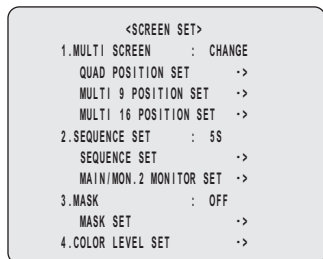

- 4 Press the [EXIT/OSD] button.

The setting procedure is ended and the display returns to the normal screen.



NOTE

- Switching interval is set for all cameras from main monitor and monitor 2.
 - The interval can be set between 1 and 30 seconds.
 - Select "INDIV." in step 2 to set automatic selection time for each display screen, monitor, or camera.
- (1) Select "INDIV." in step 2 and turn the shuttle dial clockwise
The cursor moves to "SEQUENCE SET".
 - (2) Turn the shuttle dial clockwise
The <SEQUENCE SET> screen is displayed.

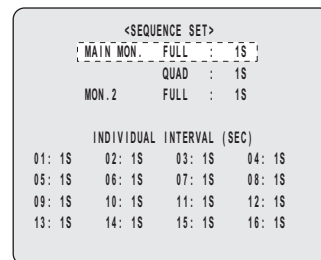

- (3) Set items with the jog dial and turn the shuttle dial clockwise to select
Select "INDIV." to set automatic selection time for each camera.

Setting the main monitor and monitor 2

Example:
Specifying a monitor to display each camera's video at the set period (as indicated by TIME PERIOD A and TIME PERIOD B).

- 1 Make timer settings for "TIME PERIOD A" and "TIME PERIOD B" from <TIME PERIOD SET>. (→P.57)

Specify "TIME PERIOD A" and "TIME PERIOD B".

- 2 Press the [MENU] button and turn the jog dial to select "4. SCREEN SET", and then turn the shuttle dial clockwise.

The <SCREEN SET> screen is displayed. The cursor moves to "1. MULTI SCREEN".

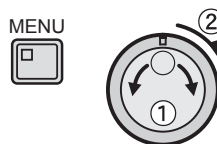

3 Turn the jog dial to move the cursor to “MAIN/MON.2 MONITOR SET”, and then turn the shuttle dial clockwise.

The <MAIN/MON.2 MONITOR SET> screen is displayed.

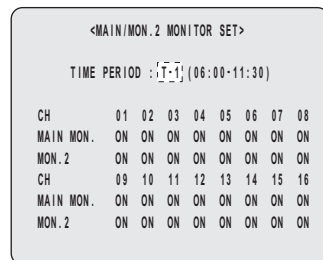

4 Turn the shuttle dial clockwise.

“T-1” starts to flash for “TIME PERIOD”.

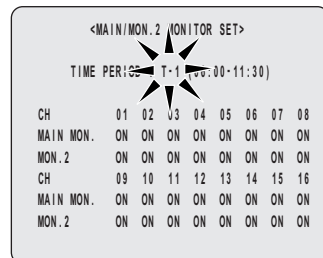

5 Turn the jog dial to select T-1, T-2, T-3, or T-4 for the time period, and then turn the shuttle dial clockwise.

After setting the period, the cursor moves to “ON” for the “MAIN MON.”.

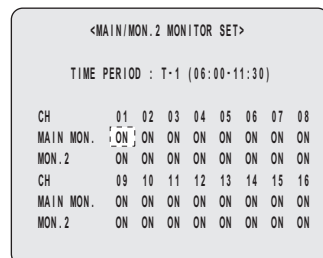

6 Turn the jog dial clockwise or counter-clockwise to move the cursor to the main-monitor or monitor 2 channel to be changed.

On the DSR-3709, select cameras No. 1 through No. 9.

7 Turn the shuttle dial clockwise.

“ON” flashes.

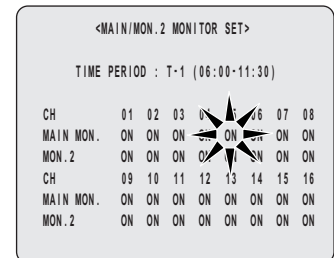

8 Turn the jog dial to select “ON” or “OFF”, and then turn the shuttle dial clockwise.

After confirming this setting, the cursor moves one position to the right.

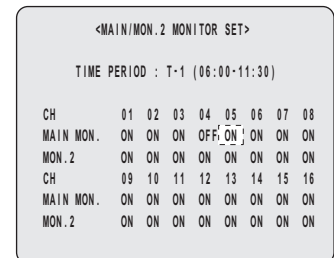

[Settings] (◆ indicates default setting)

Settings	Description
◆ON	Camera images displayed.
OFF	Camera images not displayed.

9 Use the same procedure to set the remaining channels.

10 Press the [EXIT/OSD] button.

The setting procedure is ended and the display returns to the normal screen.



NOTE

- When setting a number of time periods together, use the jog dial to move the cursor to the next period after completing step 9, and repeat the process from step 4.
- The time period for “T-1” through “T-4” changes to that of “TIME PERIOD A” or “TIME PERIOD B” on P.57.

Setting masks

Use the following procedure to set video from a specific camera (including playback video) to be masked by a gray pattern when it is not to be shown on a monitor screen.

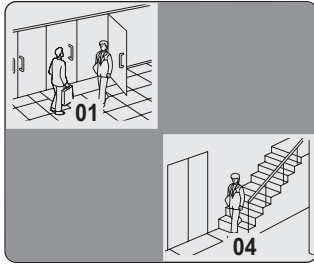

Example:

Preventing the display of unneeded camera video at the set period (as indicated by TIME PERIOD A and TIME PERIOD B).

1 Make timer settings for “TIME PERIOD A” and “TIME PERIOD B” from <TIME PERIOD SET>. (→P.57)

Specify “TIME PERIOD A” and “TIME PERIOD B”.

2 Press the [MENU] button, turn the jog dial to select “4. SCREEN SET”, and then turn the shuttle dial clockwise.

The <SCREEN SET> screen is displayed. The cursor moves to “1. MULTI SCREEN”.

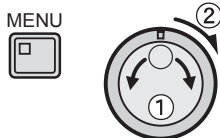

3 Turn the jog dial to move the cursor to “MASK”, and then turn the shuttle dial clockwise.

“OFF” flashes.

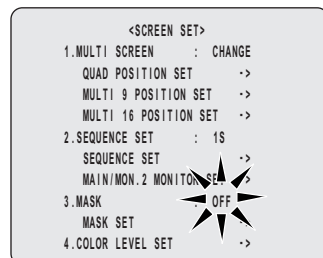

4 Turn the jog dial to select “ON”, and then turn the shuttle dial clockwise.

The cursor moves to “MASK SET”.

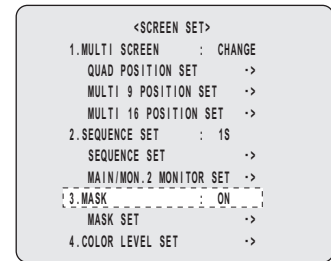

5 Turn the shuttle dial clockwise.

The <MASK SET> screen is displayed.

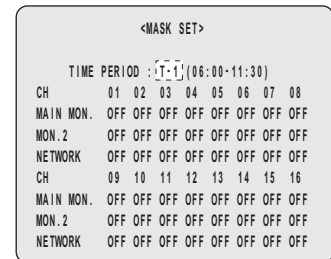

6 Turn the shuttle dial clockwise.

“T-1” starts to flash for “TIME PERIOD”.

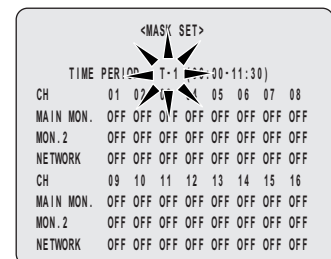

7 Turn the jog dial to select T-1, T-2, T-3, or T-4 for the time period, and then turn the shuttle dial clockwise.

After setting the period, the cursor moves to channel 01 for the “MAIN MON.”.

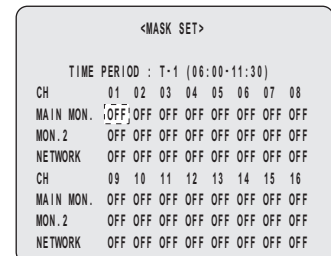

NOTE

- Each camera can be set individually for the main monitor, the monitor 2, and network video.

8 Turn the jog dial clockwise or counter-clockwise to move the cursor to channel to be changed.

On the DSR-3709, select cameras No. 1 through No. 9.

9 Turn the shuttle dial clockwise.

“OFF” flashes.

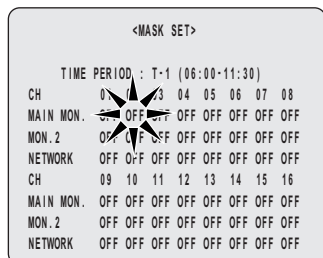

[Settings] (◆ indicates default setting)

Setting	Description
◆OFF	Masking is not performed.
ON	Masking is performed.

NOTE

- Masked channels will not display playback video. To view playback video, turn masking “OFF” in step 3.

10 Turn the jog dial to select “ON” or “OFF”, and then turn the shuttle dial clockwise.

After confirming this setting, the cursor moves one position to the right.

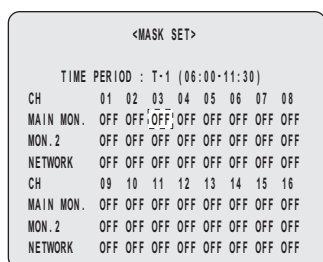

11 Use the same procedure to set the remaining channels.

12 Press the [EXIT/OSD] button.

The setting procedure is ended and the display returns to the normal screen.



NOTE

- When setting a number of time periods together, use the jog dial to move the cursor to the next period after completing step 10, and repeat the process step 6 through 10.
- The time period for “T-1” through “T-4” changes to that of “TIME PERIOD A” or “TIME PERIOD B” on P.57.
- Network mask settings are valid only for the user connecting to the network with ID1. Users connecting using ID2 and ID3 will be able to display all channels.

Setting the color level

Use the following procedure to adjust the color of video displayed on monitors.

1 Press the [MENU] button, turn the jog dial to select “4. SCREEN SET”, and then turn the shuttle dial clockwise.

The <SCREEN SET> screen is displayed. The cursor moves to “1. MULTI SCREEN”.

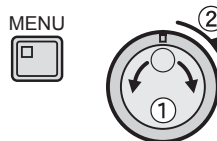

2 Turn the jog dial to select “4. COLOR LEVEL SET”, and then turn the shuttle dial clockwise.

The <COLOR LEVEL SET> screen is displayed.



- 3** Press the [CAMERA SELECT] button for the camera whose color level is to be set, and then turn the shuttle dial clockwise.

“5” flashes.

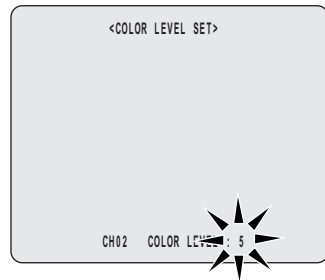

- 4** Turn the jog dial to select a “COLOR LEVEL” (1 through 10), and then turn the shuttle dial clockwise.

[Settings] (◆ indicates default setting)

Setting	Description
1 to 10 (◆5)	Manual adjustment to one of 10 levels. Light (1) to Dark (10)

- 5** Press the [EXIT/OSD] button.

The setting procedure is ended and the display returns to the normal screen.

EXIT/OSD



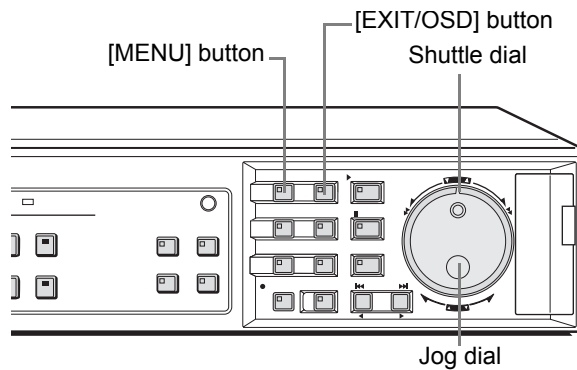
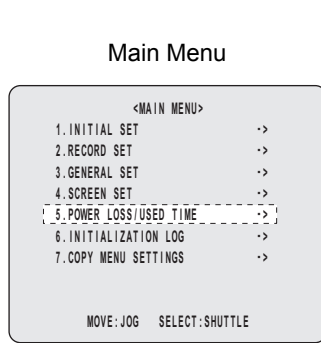

Use the following procedure to check the date and time of power losses, the amount of hard disk operation time, and the amount of power-on time.

- 1 Press the [MENU] button and turn the select “5. POWER LOSS/USED TIME”, and then turn the shuttle dial clockwise.

The <POWER LOSS/USED TIME> screen is displayed.

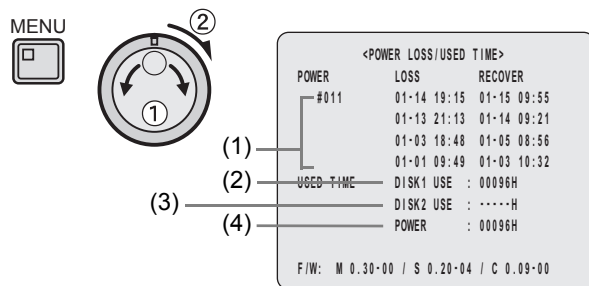

Check the date and time of power losses and the amount of hard disk operation time.

(1) LOSS/RECOVER

Display information in sequence for the four most recent power losses (i.e., the date and time of loss and recovery).

The number on the left is the number of power losses (Example: #011). For all numbers above 999, the number “999” is displayed.

(2) DISK1 USE

Displays the total amount of running time for disk 1.

(3) DISK2 USE

Displays the total amount of running time for disk 2. When only one hard disk is installed, “-----” is displayed.

(4) POWER

Displays the amount of power-on time for the digital video recorder.

2 Press the [EXIT/OSD] button.

The display returns to the normal screen.



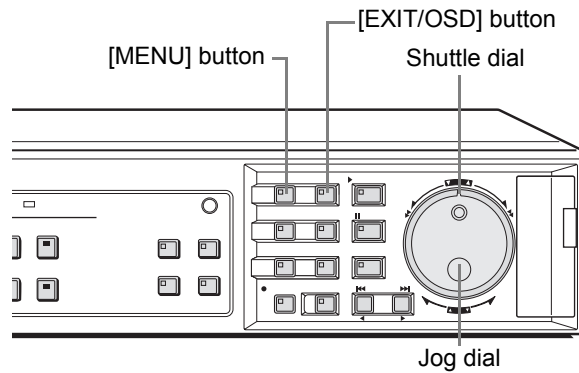
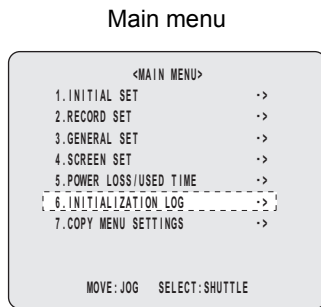

Use the following procedure to display the eight most recent entries in the initialization and re-recording log for the hard disk.

- 1 Press the [MENU] button and turn the jog dial to select “6. INITIALIZATION LOG”, and then turn the shuttle dial clockwise.

The <INITIALIZATION LOG> screen is displayed.

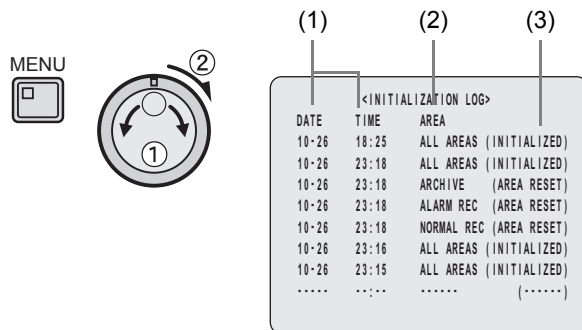

- (1) **DATE/TIME**
Displays the date and time of the operation.
- (2) **AREA**
Displays the area on which the operation was performed.
- (3) **Operation class**
Displays the operation performed as either of the following:
 - INITIALIZED
 - AREA RESET

! CAUTION

- “INITIALIZED” is displayed when recording areas have been changed.

- 2 Press the [EXIT/OSD] button.

The display returns to the normal screen.



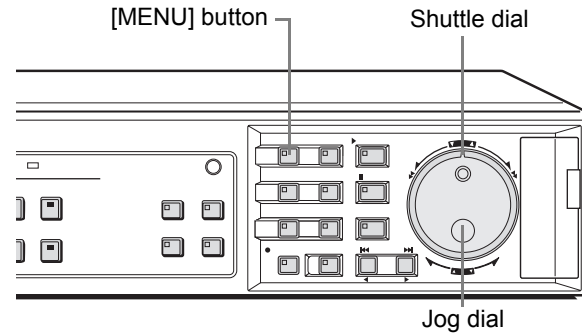
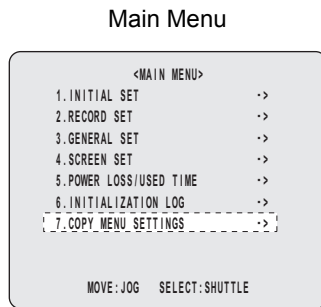

Use the following procedure to save menu settings on a CompactFlash card or to load settings from a CompactFlash card back into the digital video recorder. These functions make it easy to use the same settings on a number of different hard disk digital recorders.

- 1 Press the [MENU] button and turn the jog dial to select “7. COPY MENU SETTINGS”, and then turn the shuttle dial clockwise.**

The <COPY MENU SETTINGS> screen is displayed.

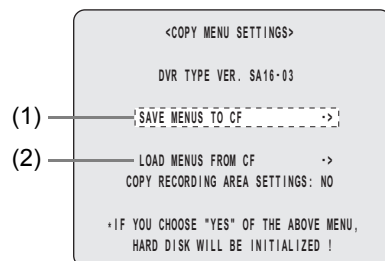

- (1) SAVE MENUS TO CF**
This saves the menu settings to a CompactFlash card.
- (2) LOAD MENUS FROM CF**
This loads menu settings into the digital video recorder from a CompactFlash card.

Saving menu settings on a CompactFlash card

Insert a CompactFlash card into the CompactFlash card slot.

- 1 Turn the jog dial to select “SAVE MENUS TO CF”, and then turn the shuttle dial clockwise.**

<WARNING> screen is displayed.



- 2 Turn the jog dial to select “YES”, and then turn the shuttle dial clockwise.**

- (1) The saving process begins.



- (2) When this has been completed, “SAVING FINISHED!!” is displayed. A file named “MENUCOPY.TXT” is created in the CompactFlash directory.



Loading settings from a CompactFlash card

Use the following procedure to load menu settings saved on a CompactFlash card back into the digital video recorder.

! CAUTION

- When loading a menu setting file into the recorder, you will be able to specify whether recording area settings are to be copied. Normally, "COPY RECORDING AREA SETTINGS" should be set to "NO". If set to "YES", hard disk initialization will be carried out as part of the loading process, and all recorded data will be lost.
- Different menu setting file formats cannot be loaded. Check that the version that is displayed in "DVR TYPE VER." matches before loading.

1 Turn the jog dial to select "LOAD MENU FROM CF", and then turn the shuttle dial clockwise.

<WARNING> screen is displayed.



2 Turn the jog dial to select "YES", and then turn the shuttle dial clockwise.

(1) The loading process begins.

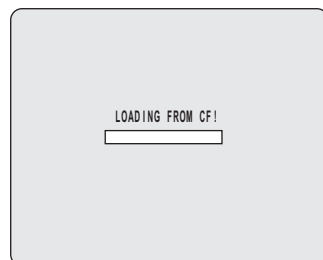

(2) When this has been completed, "SYSTEM INITIALIZING" is displayed and the display returns to the normal screen.

When copying recording area settings

Use the following procedure to copy recording area settings.

1 Turn the jog dial to select "COPY RECORDING AREA SETTINGS", and then turn the shuttle dial clockwise.

"NO" flashes.

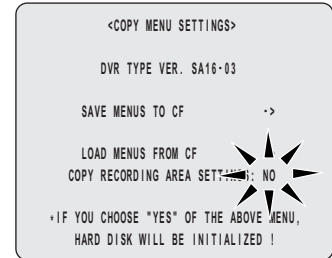

2 Turn the jog dial to select "YES", and then turn the shuttle dial clockwise.

The cursor returns to "SAVE MENU TO CF".

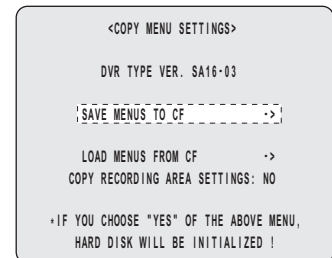

3 Turn the jog dial to select "LOAD MENU FROM CF".

4 Turn the shuttle dial clockwise.

<WARNING> screen is displayed.



5 Turn the jog dial to select "YES", and then turn the shuttle dial clockwise.

The loading process starts.

When this has been completed, "SYSTEM INITIALIZING" is displayed and the display returns to the normal screen.

! CAUTION

- Normally, "COPY RECORDING AREA SETTINGS" should be set to "NO". If set to "YES", hard disk initialization will be carried out, and all recorded data will be lost.

RS-485 specifications**Data format**

Mode	Asynchronous
Character length	8 bits
Data transmission speed	2,400, 4,800, 9,600, 19,200 bps
Parity check	None
Stop bit	1 bit

Communication protocol

A proprietary protocol (SANYO protocol) is used. Use of a special controller for operation is recommended. To obtain this controller, contact a Sanyo service center.

SANYO protocol command table

The table below shows the commands supported by the digital video recorder.

Left digit \ Right digit	0	1	2	3	4	5	6	7
0				0			TIMER ON/OFF	
1				1				
2				2				
3				3		SHIFT←	SHIFT→	
4				4		SHIFT↑	SHIFT↓	MENU
5				5			SET+ /RP UP	
6				6			SET- /RP DOWN	
7				7				
8				8				
9				9			SECURITY LOCK ON	
A	ACK			PLAY	REV PLAY/ SEARCH (DVR)		SECURITY LOCK OFF	
B	NAK							
C							GROUP SET	
D							GROUP CHECK	
E							GROUP CLEAR	
F				STOP	STILL			

Left digit \ Right digit	8	9	A	B	C	D	E	F
0		FULL1					CLOCK ADJUST	
1		FULL2					MENU RESET	
2	MULTI (MPX)	FULL3						
3	QUAD (MPX)	FULL4						
4	PLUS1 (MPX)	FULL5						
5	ZOOM (MPX/DVR)	FULL6						
6		FULL7						
7	SEQUENCE (MPX)	FULL8				STATUS SENSE		
8	MONITOR2 (MPX)	FULL9						
9		FULL10					CLOCK DOWNLOAD	
A	ALARM RESET	FULL11		CAMERA CONTROL (MPX)	REC			REC/DUB REQUEST
B		FULL12	FF/ALARM F					
C	CHANNEL	FULL13	REW/ALARM R				AUX ON	
D	COPY	FULL14					AUX OFF	RS-485 SEND START
E	EXIT/OSD	FULL15		STATUS LOG2				RS-485 RCV CMF.
F		FULL16		STATUS LOG1	REC STOP			

Specifications

Product name	Digital video recorder with multiplexer function	
Product number	DSR-3716 (16 channel), DSR-3709 (9 channel)	
Hard disk capacity	Capability for mounting 80, 160, 250, or 300 GB hard disks (sold separately)	
Television system	NTSC signal standard	
Compression	Image: M-JPEG, Audio: WAVE	
Picture resolution	720 x 240 (fields)	
Recording type	Field recording	
Picture quality	5 levels [Basic, Normal, Enhanced, Fine, Super Fine]	
Recording rate	27 levels (60 to 0.033 FPS)	
Recording areas	Normal recording area, Alarm recording area, Archive area	
Magnification	x2 digital zoom using the [ZOOM] button	
Search modes	Time/date search, Alarm search, Alarm thumbnail search, Archive area search, Motion detection search	
Date/clock settings	Month, Day, Year (last two digits), Hours, Minutes, Seconds	
Date and time positions	2 position; upper and lower (display may also be turned off)	
Camera title display	Each channel; up to 10 alphanumeric characters and symbols (display may also be turned off)	
Memory backup	Approximately 30 days (for 48 hours of electrification)	
Video input terminal	VBS/VS 1.0 V (p-p), 75 Ω, BNC (DSR-3716: x16, DSR-3709: x9)	
Video output terminal	Through output of each video input, BNC (DSR-3716: x16, DSR-3709: x9)	
Main monitor output terminal	VBS 1.0 V (p-p), 75 Ω, BNC (x1)	
Monitor 2 output terminal	VBS/VS 1.0 V (p-p), 75 Ω, BNC (x1)	
Audio input terminal	-8 dBs, 27 kΩ, unbalanced RCA (x1)	
Audio output terminal	-8 dBs, 600 Ω, unbalanced RCA (x1)	
Microphone input terminal	-60 dBs, 10 kΩ, unbalanced 3.5 mm monaural pin jack (x1)	
Front AV output	Video output terminal	1.0 Vp-p, 75 Ω, unbalanced RCA x 1
	Audio output terminal	-8 dBs, 600 Ω, unbalanced RCA x 1
CompactFlash card slot	CompactFlash Type 2 (front panel) (x1)	
Terminals	LAN terminal	10BASE-T/100BASE-TX, RJ-45 (x1) Compatible protocol: UDP, TCP/IP, HTTP server
	RS-485 terminal	RJ-11 (x2) (with a termination switch)
	USB terminal	USB 1.1 series A terminal (x2) (front x1, rear x1)
	Alarm input terminals	No-volt contacts (with a pulse width of 100 ms or more) (DSR-3716: x16, DSR-3709: x9)
	Sensor alarm output terminals	Open collector, Low level active (Max. 25 mA) (DSR-3716: x16, DSR-3709: x9)
	Remote control input terminal	Two-wire voltage control (x2)
	Clock adjust input terminal	No-volt contacts (with a pulse width of 100 ms or more) (x1)
	Clock adjust output terminal	Normal 5 V DC, Low level active (x1)
	Alarm output terminal	Active Low, Open collector Max. 500 mA (x1)
	Alarm reset input terminal	No-volt contacts (with a pulse width of 100 ms or more) (x1)
	Warning output terminal	Normal 5 V DC, Low level active (x1)
	Normal recording area disk full warning output terminal	Normal 5 V DC, Low level active (x1)
	Alarm recording area disk full warning output terminal	Normal 5 V DC, Low level active (x1)
	Series connection input	Normal 5 V DC, Low level active (x1)
	Series connection output	Normal 5 V DC, Low level active (x1)
	External timer input terminal	No-volt contacts (with a pulse width of 1 second or more) (x1)
Non rec output terminal	Normal 5 V DC, Low level active (x1)	
Power supply voltage	120 to 240 V AC, 50/60 Hz	
Current consumption	600 mA	
Allowable operating temperature	5 °C to 40 °C	
Allowable operating humidity	10 % to 80 %	
Dimensions	420 (W) x 86 (H) x 365 (D) mm (Not including protruding areas or rubber pads)	
Weight	6.3 kg with a HDD, 6.9 kg with 2 HDDs	
Accessory	Power cord (x1), Core clamp (x2), Power cord tie (x1)	

Note that product appearance and specifications are subject to change without prior notice.

Dimensions

Units: mm

DSR-3716

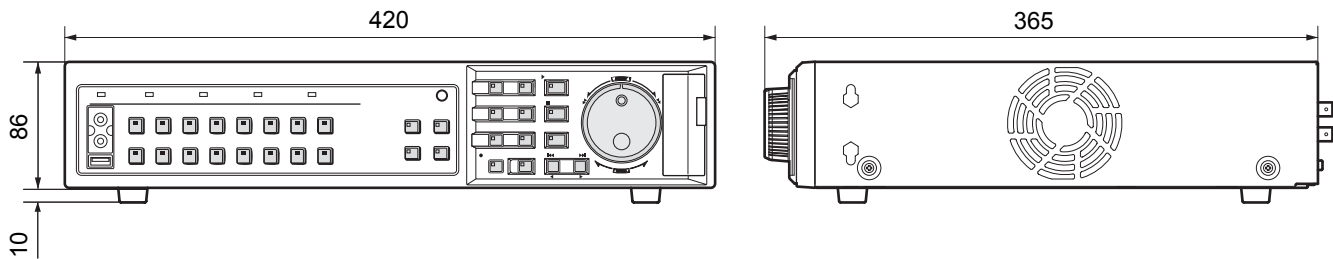

DSR-3709

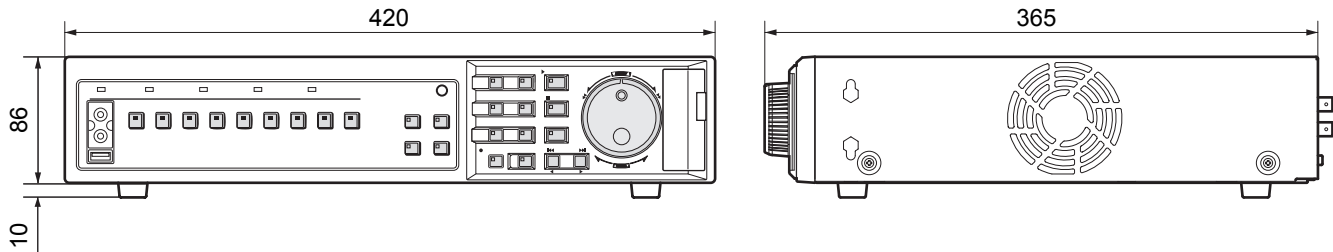

UL disclaimer statement

Underwriters Laboratories Inc. ("UL") has not tested the performance or reliability of this hardware, operating software or other aspects of this product.

UL has only tested for fire, shock or casualties as outlined in UL's Standard(s) for Safety.

UL Certification does not cover the performance or reliability of the security hardware and security operating software.

UL MAKES NO REPRESENTATIONS, WARRANTIES OR CERTIFICATIONS WHATSOEVER REGARDING THE PERFORMANCE OR RELIABILITY OF ANY SECURITY RELATED FUNCTIONS OF THIS PRODUCT.

Table of recording rate and times

This product's recording time can be changed by modifying the recording rate and the recording picture quality. The following table provides reference values for picture quality and recording rate in a situation where video is recorded to the normal recording area of this product's hard disk.

- The time setting for the normal recording area and the alarm recording area is determined by multiplying the following recording time by the percent display value for the normal recording area and the alarm recording area as specified using the menu's recording area settings.
- The recording time may change for different recording picture qualities.

■ Example: Recording to a 80 GB hard disk (100%-usage)

Recording rate FPS (field/sec)	Recording time				
	BASIC 15kB	NORMAL 22kB	ENHANCED 30kB	FINE 42kB	SUPER FINE 50kB
60.00	20H	14H	11H	8H	6H
30.00	41H	29H	22H	16H	13H
20.00	62H	44H	33H	24H	20H
15.00	82H	58H	44H	32H	27H
10.00	124H	88H	66H	48H	40H
7.50	165H	117H	88H	64H	54H
6.00	207H	146H	110H	80H	67H
5.00	248H	176H	132H	96H	81H
4.29	290H	205H	154H	112H	94H
3.75	331H	235H	176H	128H	108H
3.33	373H	264H	198H	144H	122H
3.00	414H	293H	220H	160H	135H
2.73	456H	323H	242H	176H	149H
2.31	539H	382H	286H	208H	176H
2.00	622H	440H	330H	240H	203H
1.67	746H	529H	396H	288H	244H
1.43	871H	617H	462H	336H	284H
1.25	995H	705H	529H	384H	325H
1.11	1120H	793H	595H	432H	366H
1.00	1244H	881H	661H	480H	406H
0.50	2489H	1763H	1322H	961H	813H
0.33	3734H	2645H	1983H	1442H	1220H
0.25	4978H	3526H	2645H	1923H	1627H
0.20	6223H	4408H	3306H	2404H	2034H
0.10	12447H	8816H	6612H	4809H	4069H
0.05	24894H	17633H	13225H	9618H	8138H
0.03	37341H	26450H	19837H	14427H	12207H

■ Example: Recording to a 160 GB hard disk (100%-usage)

Recording rate FPS (field/sec)	Recording time				
	BASIC 15kB	NORMAL 22kB	ENHANCED 30kB	FINE 42kB	SUPER FINE 50kB
60.00	41H	29H	22H	16H	13H
30.00	83H	59H	44H	32H	27H
20.00	124H	88H	66H	48H	40H
15.00	166H	118H	88H	64H	54H
10.00	249H	177H	132H	96H	81H
7.50	333H	236H	177H	128H	108H
6.00	416H	295H	221H	160H	136H
5.00	499H	354H	265H	193H	163H
4.29	583H	413H	309H	225H	190H
3.75	666H	472H	354H	257H	217H
3.33	749H	531H	398H	289H	245H
3.00	833H	590H	442H	321H	272H
2.73	916H	649H	486H	354H	299H
2.31	1083H	767H	575H	418H	354H
2.00	1249H	885H	663H	482H	408H
1.67	1499H	1062H	796H	579H	490H
1.43	1749H	1239H	929H	676H	572H
1.25	1999H	1416H	1062H	772H	653H
1.11	2249H	1593H	1195H	869H	735H
1.00	2499H	1770H	1327H	965H	817H
0.50	4999H	3541H	2655H	1931H	1634H
0.33	7498H	5311H	3983H	2897H	2451H
0.25	9998H	7082H	5311H	3863H	3268H
0.20	12498H	8852H	6639H	4828H	4085H
0.10	24996H	17705H	13279H	9657H	8171H
0.05	49992H	35411H	26558H	19315H	16343H
0.03	74988H	53116H	39837H	28972H	24515H

Area in which sound recording is possible (when recording sound, the recording time is shorter than that shown above.)

■ Example: Recording to a 300 GB hard disk (100%-usage)

Recording rate FPS (field/sec)	Recording time				
	BASIC 15kB	NORMAL 22kB	ENHANCED 30kB	FINE 42kB	SUPER FINE 50kB
60.00	78H	55H	41H	30H	25H
30.00	156H	110H	83H	60H	51H
20.00	234H	166H	124H	90H	76H
15.00	313H	221H	166H	120H	102H
10.00	469H	332H	249H	181H	153H
7.50	626H	443H	332H	241H	204H
6.00	782H	554H	415H	302H	255H
5.00	939H	665H	498H	362H	307H
4.29	1095H	776H	582H	423H	358H
3.75	1252H	886H	665H	483H	409H
3.33	1408H	997H	748H	544H	460H
3.00	1565H	1108H	831H	604H	511H
2.73	1721H	1219H	914H	665H	562H
2.31	2034H	1441H	1080H	786H	665H
2.00	2347H	1663H	1247H	907H	767H
1.67	2817H	1995H	1496H	1088H	921H
1.43	3286H	2328H	1746H	1269H	1074H
1.25	3756H	2660H	1995H	1451H	1228H
1.11	4226H	2993H	2245H	1632H	1381H
1.00	4695H	3326H	2494H	1814H	1535H
0.50	9391H	6652H	4989H	3628H	3070H
0.33	14087H	9978H	7483H	5442H	4605H
0.25	18782H	13304H	9978H	7256H	6140H
0.20	23478H	16630H	12472H	9071H	7675H
0.10	46956H	33261H	24945H	18142H	15351H
0.05	93913H	66522H	49891H	36284H	30702H
0.03	140870H	99783H	74837H	54427H	46053H

Area in which sound recording is possible (when recording sound, the recording time is shorter than that shown above.)

Table of recording rate settings

Normal recording rate

Display sequence	Recording rate FPS (field/sec)
1	60.00 (Note1, 2)
2	30.00
3	20.00
4	15.00
5	10.00
6	7.50
7	6.00
8	5.00
9	4.29
10	3.75
11	3.33
12	3.00
13	2.73
14	2.31
15	2.00
16	1.67
17	1.43
18	1.25
19	1.11
20	1.00
21	0.50
22	0.33
23	0.25
24	0.20
25	0.10
26	0.05
27	0.03

Alarm recording rate

Display sequence	Recording rate FPS (field/sec)
1	30.00
2	20.00
3	15.00
4	10.00
5	7.50
6	6.00
7	5.00
8	4.29
9	3.75
10	3.33
11	3.00
12	2.73
13	2.31
14	2.00
15	1.67
16	1.43
17	1.25
18	1.11
19	1.00
20	0.50
21	0.33
22	0.25
23	0.20
24	0.10
25	0.05
26	0.03

Pre-alarm recording rate

Display sequence	Recording rate FPS (field/sec)
1	30.00
2	20.00
3	15.00
4	10.00
5	7.50
6	6.00
7	5.00
8	4.29
9	3.75
10	3.33
11	3.00
12	2.73
13	2.31
14	2.00
15	1.67
16	1.43
17	1.25
18	1.11
19	1.00

(Note 1) 30 FPS maximum when pre-alarm recording is set to "ON".

(Note 2) 30 FPS maximum when recording only one camera; 60 FPS maximum when recording two or more cameras.

Program recording rate

Display sequence	Recording rate FPS (field/sec)
1 (Note1)	30
2	15
3	7.5
4	3.75
5	1.875
6	1.000
7	0.500
8	0.330
9	0.250
10	0.200
11	0.100
12	0.050
13	0.033
14	

This table indicates recording rate settings for individual cameras.

When making settings for multiple cameras, ensure that the total recording rate is within 60 FPS.

Settings are adjusted automatically to ensure that the total recording rate is within 60 FPS; accordingly, if a setting value cannot be raised, the value for a different camera must first be lowered.

* FPS stands for fields per second, the number of images that are recorded in a single second.

(Note 1) A selection cannot be made when pre-alarm recording has been set to "ON".

Table of pre-alarm recording times

This table indicates recording times for pre-alarm recording, and it should be used when this type of recording is being carried out.

Recording rate FPS (field/sec)	Recording time (Display of time on menu screens s: seconds m: minutes)											
	3s (3s)	5s (5s)	10s (10s)	20s (20s)	40s (40s)	60s (1m)	120s (2m)	180s (3m)	240s (4m)	300s (5m)	500s (10m)	900s (15m)
30.00	<input type="radio"/>	<input type="radio"/>	<input type="radio"/>	<input type="radio"/>	<input type="radio"/>	<input type="radio"/>	<input type="radio"/>	<input type="radio"/>	<input type="radio"/>	<input type="radio"/>	<input type="radio"/>	<input type="radio"/>
20.00		<input type="radio"/>	<input type="radio"/>	<input type="radio"/>	<input type="radio"/>	<input type="radio"/>	<input type="radio"/>	<input type="radio"/>	<input type="radio"/>	<input type="radio"/>	<input type="radio"/>	<input type="radio"/>
15.00		<input type="radio"/>	<input type="radio"/>	<input type="radio"/>	<input type="radio"/>	<input checked="" type="radio"/>	<input type="radio"/>	<input type="radio"/>	<input type="radio"/>	<input type="radio"/>	<input type="radio"/>	<input type="radio"/>
10.00			<input type="radio"/>	<input type="radio"/>	<input type="radio"/>	<input type="radio"/>	<input type="radio"/>	<input type="radio"/>	<input type="radio"/>	<input type="radio"/>	<input type="radio"/>	<input type="radio"/>
7.50			<input type="radio"/>	<input type="radio"/>	<input type="radio"/>	<input type="radio"/>	<input type="radio"/>	<input type="radio"/>	<input type="radio"/>	<input type="radio"/>	<input type="radio"/>	<input type="radio"/>
6.00			<input type="radio"/>	<input type="radio"/>	<input type="radio"/>	<input type="radio"/>	<input type="radio"/>	<input type="radio"/>	<input type="radio"/>	<input type="radio"/>	<input type="radio"/>	<input type="radio"/>
5.00				<input type="radio"/>	<input type="radio"/>	<input type="radio"/>	<input type="radio"/>	<input type="radio"/>	<input type="radio"/>	<input type="radio"/>	<input type="radio"/>	<input type="radio"/>
4.29				<input type="radio"/>	<input type="radio"/>	<input type="radio"/>	<input type="radio"/>	<input type="radio"/>	<input type="radio"/>	<input type="radio"/>	<input type="radio"/>	<input type="radio"/>
3.75				<input type="radio"/>	<input type="radio"/>	<input type="radio"/>	<input type="radio"/>	<input type="radio"/>	<input type="radio"/>	<input type="radio"/>	<input type="radio"/>	<input type="radio"/>
3.33				<input type="radio"/>	<input type="radio"/>	<input type="radio"/>	<input type="radio"/>	<input type="radio"/>	<input type="radio"/>	<input type="radio"/>	<input type="radio"/>	<input type="radio"/>
3.00				<input type="radio"/>	<input type="radio"/>	<input type="radio"/>	<input type="radio"/>	<input type="radio"/>	<input type="radio"/>	<input type="radio"/>	<input type="radio"/>	<input type="radio"/>
2.73				<input type="radio"/>	<input type="radio"/>	<input type="radio"/>	<input type="radio"/>	<input type="radio"/>	<input type="radio"/>	<input type="radio"/>	<input type="radio"/>	<input type="radio"/>
2.31					<input type="radio"/>	<input type="radio"/>	<input type="radio"/>	<input type="radio"/>	<input type="radio"/>	<input type="radio"/>	<input type="radio"/>	<input type="radio"/>
2.00					<input type="radio"/>	<input type="radio"/>	<input type="radio"/>	<input type="radio"/>	<input type="radio"/>	<input type="radio"/>	<input type="radio"/>	<input type="radio"/>
1.67						<input type="radio"/>	<input type="radio"/>	<input type="radio"/>	<input type="radio"/>	<input type="radio"/>	<input type="radio"/>	<input type="radio"/>
1.43						<input type="radio"/>	<input type="radio"/>	<input type="radio"/>	<input type="radio"/>	<input type="radio"/>	<input type="radio"/>	<input type="radio"/>
1.25						<input type="radio"/>	<input type="radio"/>	<input type="radio"/>	<input type="radio"/>	<input type="radio"/>	<input type="radio"/>	<input type="radio"/>
1.11						<input type="radio"/>	<input type="radio"/>	<input type="radio"/>	<input type="radio"/>	<input type="radio"/>	<input type="radio"/>	<input type="radio"/>
1.00						<input type="radio"/>	<input type="radio"/>	<input type="radio"/>	<input type="radio"/>	<input type="radio"/>	<input type="radio"/>	<input type="radio"/>

Default setting, Recording rate: 15 FPS, Recording time: 1 min.

When setting alarm durations using a menu, settings will be restricted to those available for the selected recording rate. Similarly, when setting recording rates, the setting range will be restricted to that available for the selected duration. For example, if the alarm duration is set to 3 seconds, only 30 FPS will be selectable for the recording rate.

When setting fast recording rates, it may be necessary to first of all change the alarm duration setting.

Terminal board specifications

Input/output terminals	Signal level	Input/output circuit
Alarm input [No-volt contacts]	<p>Open ground input</p> <p>0V</p> <p>100ms or more</p>	<p>Terminal</p> <p>1k</p> <p>5V</p> <p>100k</p> <p>10k</p> <p>IC 74HC597</p>
Sensor alarm output [Open collector/1k Ω , Low level active (max: 25mA)]	<p>Open</p> <p>0V</p> <p>Detect motion sensor</p> <p>Stop alarm recording</p>	<p>IC BU209</p> <p>1k</p> <p>Terminal</p>
CTL2,3 Remote control input [Two-wire voltage control] (\rightarrow P.14)		<p>Remote control terminal</p> <p>4.7k</p> <p>5V</p> <p>1k</p> <p>Sub micro processor</p>
CTL4 Clock adjust input [No-volt contacts]	<p>Open ground input</p> <p>0V</p> <p>100ms or more</p>	<p>Terminal</p> <p>1k</p> <p>5V</p> <p>100k</p> <p>10k</p> <p>IC 74HC597</p>
CTL5 Clock adjust output [Normal 5V/5.7k Ω , Low level active]	<p>5V</p> <p>0V</p> <p>Approx. 1 second</p>	<p>IC BU209</p> <p>5V</p> <p>4.7k</p> <p>1k</p> <p>Terminal</p>
CTL6 Alarm output [Open collector/1k Ω , Low level active (max: 500mA)]	<p>Open</p> <p>0V</p> <p>Start alarm recording</p> <p>Finish alarm recording</p>	<p>IC BU209</p> <p>5V</p> <p>4.7k</p> <p>1k</p> <p>Terminal</p>
CTL7 Alarm reset input [No-volt contacts]	<p>Open ground input</p> <p>0V</p> <p>100ms or more</p>	<p>Terminal</p> <p>1k</p> <p>5V</p> <p>100k</p> <p>10k</p> <p>IC 74HC597</p>

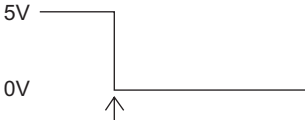
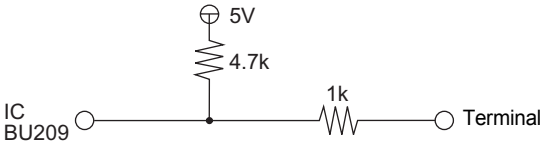
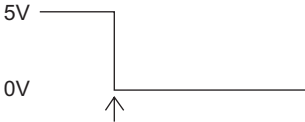
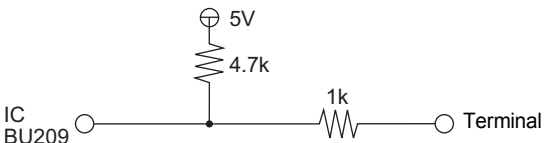
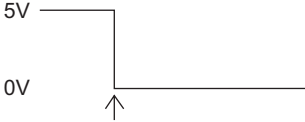
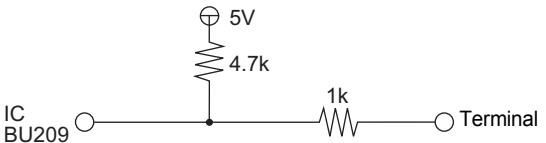
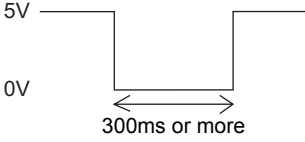
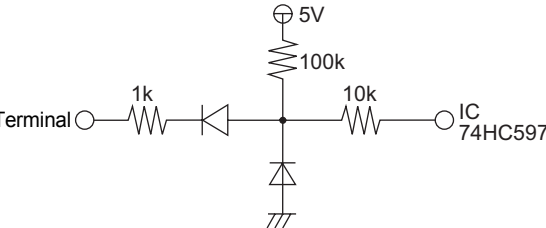
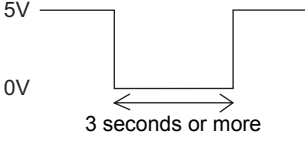
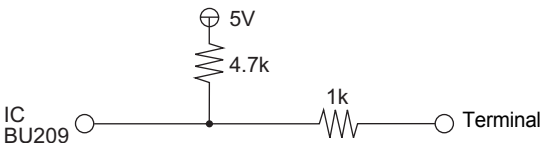
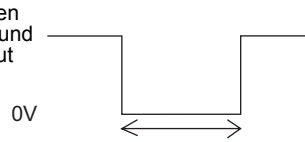
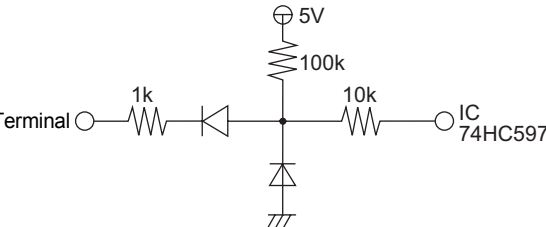
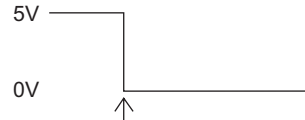
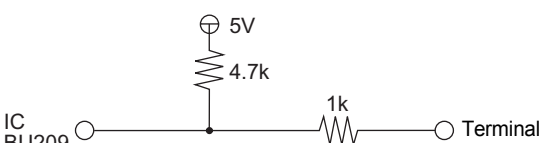
Input/output terminals	Signal level	Input/output circuit
CTL8 Warning output [DC5V/5.7kΩ, Active Low]	 <p>Warning conditions established (HDD error, FAN error detected)</p>	
CTL9 Normal recording area disk full warning output [DC5V/5.7kΩ, Active Low]	 <p>Warning conditions established (no space in normal recording area)</p>	
CTL10 Alarm recording area disk full warning output [DC5V/5.7kΩ, Active Low]	 <p>Warning conditions established (no space in alarm recording area)</p>	
CTL11 Series connection input [DC5V/5.7kΩ, Active Low]	 <p>300ms or more</p>	
CTL12 Series connection output [DC5V/5.7kΩ, Active Low]	 <p>3 seconds or more</p>	
CTL13 External timer input [No-volt contacts]	 <p>100ms or more</p>	
CTL14 Non rec output [DC5V/5.7kΩ, Active Low]	 <p>Stop recording</p>	

OTHER

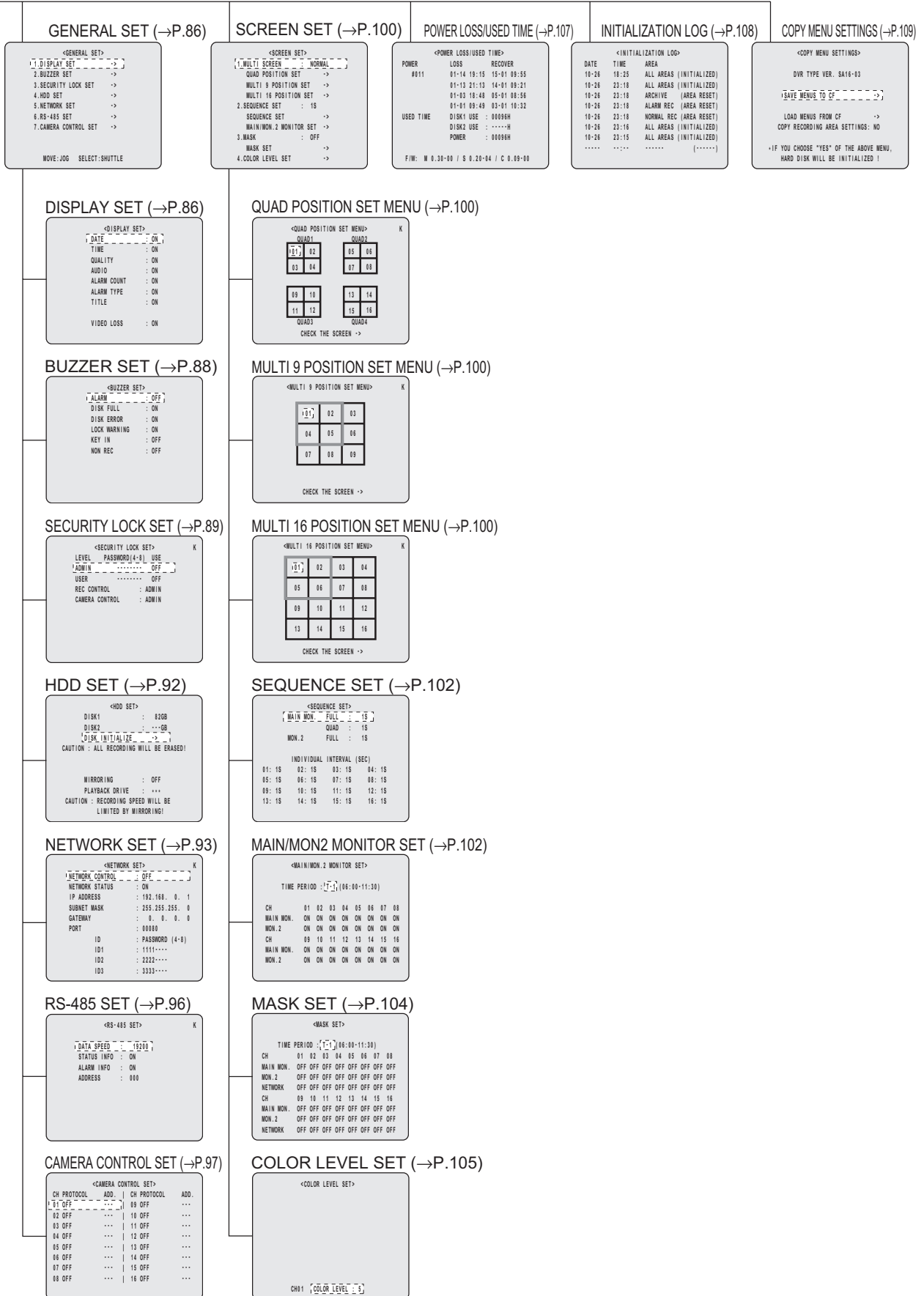

OTHER

A

Administrator	89
ALARM FULL indicator	7
ALARM indicator	7
ALARM OPERATION SET	84
ALARM PRIORITY	85
Alarm recording	24
Alarm recording area	18
ALARM RETRIGGER	84
Alarm search	31
Alarm thumbnail search	32
ALARM TRIGGER	81
ALARM TYPE	87
Archive area	18
Archive area search	34
AREA FULL RESET	66
AUDIO RECORDING	62
AUTO DELETE	71
Automatic screen selection	21

B

BUZZER SET	88
------------------	----

C

CAMERA CONTROL SET	13, 97
CAMERA DETECT	54
CAMERA SELECT	7
Canceling alarms	85
CD-R/RW	45
Changing recording areas	65
CLOCK SET	17
CompactFlash card	41

D

DISK ERROR	88
DURATION	79

E

Expanding the hard disk capacity	93
External clock setting	53

F

FULL indicator	7
Full screen	19

G

GATEWAY	95
GENERAL SET	86

H

Hard disk settings	92
--------------------------	----

I

INITIAL SET	51
INITIALIZATION LOG	108
Initializing the hard disk	92
IP ADDRESS	95

K

KEY IN	88
--------------	----

L

LEVEL	83
LOCK indicator	7
LOCK WARNING	88

M

MAIN MENU	47
Main monitor	102
MENU RESET button	48
MIRRORING	93
MODE	83
Monitor 2 (MON2)	21, 102
Motion detection search	34
MOTION SENSOR	81
Multi screen	20

N

Network settings	93
NORMAL REC EASY SET	60
Normal recording	23
Normal recording area	18
Normal recording easy setup	60

P

PASSWORD setting	89
PICTURE QUALITY	62
PLAYBACK DRIVE	93
Plus screen	20
PORT	95
POWER LOSS/USED TIME	107
Pre-alarm recording	25
PRECAUTION	1

Q

Quad screen	19
Quick print	43

R

REC CONTROL	91
REC RATE BASE	63
RECORD SET	60
Recording areas	64
Recording days	61
RECORDING DURATION BASE	61
Recording pattern	79
Recording rate	63
REMAINING DISK WARNING	68
RS-485	11, 96, 111

S

Saving user settings	109
SCREEN SET	100
SECURITY LOCK SET	89
SEQUENCE SET	102

Series recording 69
Setting alarm recording 77
Setting camera titles 55
Setting data display 86
Setting display for video loss 87
Setting holidays 56
Setting masks 104
Setting normal recording 71
Setting program recording 73
Setting quad positions 100
Setting recording conditions 67
Setting the color level 105
Setting time periods 57
SHUTTLE HOLD 27
SUBNET MASK 95

T

Time/date search 32
Timer recording 23
Timer settings 74

U

USER 90

Z

ZOOM 27



SANYO Electric Co., Ltd.

Printed in Japan

Printed on recycled paper
1AC6P1P2874--
L8HBG/US, L8HBH/US (1204TR-SY)